

**CADET PROGRAM PUBLICATIONS**

**INTERIM AMENDMENT  
A18-003**

Effective 2018-10-16

1. The following publications amendments are issued on authority of the Chief of the Defence Staff and applies to the following publications:

- a. A-CR-CCP-177/PT-001,  
*Canadian Cadet Movement  
Cadet Marksmanship Program  
reference manual remove part 4*

2. This interim amendment will be rescinded when A-CR-CCP-177/PT-001 is revised and published.

**PUBLICATIONS DU PROGRAMME**

**DES CADETS  
MODIFICATION INTÉRIMAIRE  
A18-003**

En vigueur le 2018-10-16

1. Les modifications intérimaires qui suivent sont autorisées par le Chef d'état-major de la Défense, et elles s'appliquent aux publications ci-après mentionnées.

- a. A-CR-CCP-177/PT-002,  
*Mouvement des cadets du  
Canada Manuel de référence  
programme de tir de précision  
des cadets retirer la partie 4.*

2. Cette modification intérimaire sera annulée lorsque l'A-CR CCP-177/PT-002 sera révisé et publié.

Instructions:	Instructions:
1. Remove Part 4 including all its Annexes.	1. Retirer la partie 4 et toutes ses annexes.
2. Part 4 has been replaced by A-CR-CCP-177/PS-001 Canadian Cadet Organizations Marksmanship Championships Series Rulebook.	2. La partie 4 a été remplacée par l'A-CR-CCP-177/PS-002 Livre des règlements des championnats de tir de précision des Organisations de cadets du Canada.

DCOS Trg Ops/Plans/Dev  
Natl CJCR Sp Gp

SCEM Ent Ops/Plan/Dev  
Gp S Natl CJCR





National Défense  
Defence nationale

A-CR-CCP-177/PT-001

**CANADIAN CADET MOVEMENT**

**CADET MARKSMANSHIP PROGRAM**

**REFERENCE MANUAL**

(ENGLISH)

**(Supersedes A-CR-CCP-177/PT-001 dated 2001-09-01)**

Cette publication est disponible en français sous le numéro A-CR-CCP-177/PT-002.

**Issued on Authority of the Chief of the Defence Staff**

**OPI : NDHQ D Cdts 3**

**2005-09-14**

**Canada**<sup>🇨🇦</sup>

**LIST OF EFFECTIVE PAGES**

Insert latest changed pages and dispose of superseded pages in accordance with applicable orders.

**NOTE**

The portion of the text affected by the latest change is indicated by a black vertical line in the margin of the page. Changes to illustrations are indicated by miniature pointing hands or black vertical lines.

Dates of issue for original and changed pages are:

Original .....	0 .....	2005-09-14	Ch .....	3 .....
Ch .....	1 .....		Ch .....	4 .....
Ch .....	2 .....		Ch .....	5 .....

Zero in Change No. column indicates an original page. Total number of pages in this publication is 239 consisting of the following:

<b>Page No.</b>	<b>Change No.</b>	<b>Page No.</b>	<b>Change No.</b>
Title .....	0	1B-1/1B-2.....	0
A.....	0	1C-1 to 1C-2.....	0
i to v/vi.....	0	Title – Part 2 .....	0
Title – Part 1.....	0	2-i/2-ii.....	0
1-i to 1-iii/1-iv.....	0	2-1 to 2-26 .....	0
1-1-1/1-1-2 .....	0	Title – Part 3 .....	0
1-2-1 to 1-2-2 .....	0	3-i/3-ii.....	0
1-3-1 to 1-3-4 .....	0	3-1 to 3-31 .....	0
1-4-1 to 1-4-4 .....	0	Title – Part 4 .....	0
1-5-1 to 1-5-15/1-5-16.....	0	4-i to 4-ii.....	0
1-6-1 to 1-6-12 .....	0	4-1-1/4-1-2.....	0
1-7-1 to 1-7-12 .....	0	4-2-1 to 4-2-4.....	0
1-8-1 to 1-8-4 .....	0	4-3-1 to 4-3-7/4-3-8 .....	0
1-9-1 to 1-9-3/1-9-4 .....	0	4-4-1 to 4-4-36.....	0
1-10-1 to 1-10-2 .....	0	4A-1/4A-2.....	0
1-11-1 to 1-11-6 .....	0	4B-1/4B-2.....	0
1-12-1 to 1-12-3/1-12-4 .....	0	4C-1/4C-2 .....	0
1-13-1 to 1-13-3/1-13-4.....	0	4D-1/4D-2 .....	0
1-14-1 to 1-14-5/1-14-6.....	0	4E-1/4E-2.....	0
1-15-1/1-15-2 .....	0	4F-1/4F-2.....	0
1-16-1 to 1-16-2 .....	0	GL-1 to GL-5/GL-6.....	0
1A-1/1A-2 .....	0	LA-1/LA-2.....	0

**Contact Officer: NDHQ D Cdts 3**

© 2005 DND/MDN Canada

## TABLE OF CONTENTS

	<b>PAGE</b>
<b>PART 1 – AIR RIFLE TRAINING MANUAL .....</b>	<b>1-1-1/1-1-2</b>
<b>Section 1 – General.....</b>	<b>1-1-1/1-1-2</b>
<b>Section 2 – Cadet Marksmanship Programme.....</b>	<b>1-2-1</b>
2.1 Scope.....	1-2-1
2.2 Aim of Programme.....	1-2-1
2.3 Programme Objectives .....	1-2-1
2.4 Skill Development.....	1-2-1
2.5 Corps/Squadron Training.....	1-2-2
2.6 Summer Courses.....	1-2-2
<b>Section 3 – Safety .....</b>	<b>1-3-1</b>
3.1 Safety Precautions.....	1-3-1
3.2 Safety Regulations.....	1-3-3
3.3 Range Safety Officer Training .....	1-3-3
3.4 Lead Contamination: Disposal of Lead and Personal Hygiene .....	1-3-4
<b>Section 4 – The Daisy 853C Air Rifle and Pellets .....</b>	<b>1-4-1</b>
4.1 Characteristics .....	1-4-1
4.2 Parts.....	1-4-1
4.3 Air Rifle Pellets.....	1-4-3
<b>Section 5 – Marksmanship Techniques – Prone Position .....</b>	<b>1-5-1</b>
5.1 Proper Eye Usage.....	1-5-1
5.2 The Prone Position .....	1-5-2
5.3 Aiming .....	1-5-5
5.4 Breathing.....	1-5-8
5.5 Trigger Control.....	1-5-9
5.6 Follow-Through.....	1-5-10
5.7 Loading, Firing and Unloading.....	1-5-10
5.8 Immediate Action and Stoppages.....	1-5-13
5.9 Dry Firing .....	1-5-14
5.10 Use of the Sling.....	1-5-14
<b>Section 6 – Marksmanship Techniques – Standing Position.....</b>	<b>1-6-1</b>
6.1 The Standing Position.....	1-6-1
6.2 Aiming .....	1-6-5
6.3 Breathing.....	1-6-8
6.4 Trigger Control.....	1-6-9
6.5 Follow-through .....	1-6-10
6.6 Loading, Firing and Unloading.....	1-6-10
<b>Section 7 – Marksmanship Techniques – Kneeling Position .....</b>	<b>1-7-1</b>
7.1 The Kneeling Position.....	1-7-1
7.2 Use of the Sling.....	1-7-4
7.3 Aiming .....	1-7-6
7.4 Breathing.....	1-7-9
7.5 Trigger Control.....	1-7-9
7.6 Follow-Through.....	1-7-10
7.7 Loading, Firing and Unloading.....	1-7-10

## TABLE OF CONTENTS (Cont)

	<b>PAGE</b>
<b>Section 8 – Ranges and Range Procedures</b> .....	<b>1-8-1</b>
8.1 General Safety .....	1-8-1
8.2 Portable Range Set-up and Maintenance.....	1-8-1
8.3 Range Types.....	1-8-2
8.4 Range Commands and Procedures .....	1-8-3
<b>Section 9 – Target and Scoring</b> .....	<b>1-9-1</b>
9.1 Targets.....	1-9-1
9.2 Scoring.....	1-9-1
<b>Section 10 – Cleaning</b> .....	<b>1-10-1</b>
10.1 Cleaning the Bore .....	1-10-1
10.2 Cleaning of Other Parts .....	1-10-2
<b>Section 11 – Maintenance</b> .....	<b>1-11-1</b>
11.1 Types of Maintenance.....	1-11-1
11.2 Disassembling the Rifle .....	1-11-2
11.3 Reassembling the Rifle.....	1-11-4
<b>Section 12 – Introduction to Coaching</b> .....	<b>1-12-1</b>
12.1 General .....	1-12-1
12.2 Duties.....	1-12-1
12.3 Firing Point Sequence.....	1-12-1
12.4 Competition Firing.....	1-12-2
12.5 Analysis of Common Errors .....	1-12-2
<b>Section 13 – Marksmanship Equipment</b> .....	<b>1-13-1</b>
13.1 General .....	1-13-1
13.2 Marksmanship Apparel .....	1-13-1
<b>Section 14 – Physical Training</b> .....	<b>1-14-1</b>
14.1 General .....	1-14-1
14.2 Warm-up Exercises to be Done Before Static Stretching.....	1-14-1
14.3 Static Stretching Exercises .....	1-14-2
14.4 Diet.....	1-14-4
14.5 Relaxation Techniques .....	1-14-4
<b>Section 15 – Mental Training</b> .....	<b>1-15-1/1-15-2</b>
15.1 General .....	1-15-1/1-15-2
15.2 Mental Imagery .....	1-15-1/1-15-2
<b>Section 16 – Training Plan &amp; Marksmanship Diary</b> .....	<b>1-16-1</b>
16.1 Goals.....	1-16-1
16.2 Training Plan.....	1-16-1
16.3 Marksmanship Diary .....	1-16-2
16.4 Sample Diary Sheet.....	1-16-2

**TABLE OF CONTENTS (Cont)**

	<b>PAGE</b>
<b>Annex A – Development of a Marksmanship Team.....</b>	<b>1A-1/1A-2</b>
<b>Annex B – Air Rifle Grouping Template .....</b>	<b>1B-1/1B-2</b>
<b>Annex C – Marksmanship Reference Material .....</b>	<b>1C-1</b>
<b>PART 2 – AIR RIFLE TRAINING AIDE-MÉMOIRE .....</b>	<b>2-1</b>
General .....	2-1
Safety .....	2-2
Air Rifle Ranges .....	2-4
The Daisy 853C Air Rifle and Pellets .....	2-5
Proper Eye Usage.....	2-6
Prone Position.....	2-7
Standing Position .....	2-9
Kneeling Position .....	2-11
Aiming .....	2-13
Natural Alignment .....	2-14
Breathing.....	2-15
Trigger Control and Follow-through .....	2-16
Use of the Sling.....	2-17
Loading, Firing and Unloading the Air Rifle .....	2-18
Pumping the Air Rifle .....	2-19
Cleaning the Air Rifle .....	2-20
Immediate Action and Stoppages .....	2-21
Range Commands and Procedures.....	2-22
Marksmanship Equipment .....	2-23
Physical Training.....	2-25
Coaching .....	2-26
<b>PART 3 – UNIT MARKSMANSHIP TRAINING PLAN.....</b>	<b>3-1</b>
<b>Introduction .....</b>	<b>3-1</b>
<b>Unit Marksmanship Team – Yearly Training Plan Overview .....</b>	<b>3-2</b>
<b>General Preparation Phase (6 Weeks – 01 Oct – 15 Nov) .....</b>	<b>3-4</b>
Week 1 – First Team Selection.....	3-4
Week 2 – Application of Marksmanship Principles I.....	3-5
Week 3 – Application of Marksmanship Principles II.....	3-6
Week 4 – Application of Marksmanship Principles III.....	3-7
Week 5 – Application of Marksmanship Principles IV.....	3-8
Week 6 – The Sling and Marksmanship Equipment.....	3-9
<b>Specific Preparation Phase (6 Weeks – 15 Nov – 22 Dec) .....</b>	<b>3-10</b>
Week 7 – Relaxation Techniques .....	3-10
Week 8 – Development of a Shot Routine I.....	3-11
Week 9 – Development of a Shot Routine II.....	3-12
Week 10 – Endurance Training I .....	3-13
Week 11 – Mental Training.....	3-14
Week 12 – Break .....	3-16

## TABLE OF CONTENTS (Cont)

	<b>PAGE</b>
<b>Pre-competition Phase (7 Weeks – 22 Dec – 15 Feb)</b> .....	<b>3-17</b>
Week 13 – Match Routine I.....	3-17
Week 14 – Match Routine II.....	3-18
Week 15 – Endurance Training II.....	3-19
Week 16 – Rhythm Training.....	3-20
Week 17 – Endurance Training III.....	3-21
Week 18 – Competition Simulation I.....	3-22
Week 19 – Competition Simulation II.....	3-23
<b>Competition Phase (6 to 8 Weeks – 15 Feb – 15 April)</b> .....	<b>3-24</b>
Week 20 – Development of Tactics.....	3-24
Week 21 – Competition Simulation III.....	3-25
Week 22 – Endurance Training IV.....	3-26
Week 23 – Competition Simulation IV.....	3-27
Week 24 – Zone Championship.....	3-28
Week 25 – Development of a Shot Routine III.....	3-29
Week 26 – Competition Simulation V.....	3-30
Week 27 – Provincial Championship.....	3-31
<b>PART 4 – MARKSMANSHIP CHAMPIONSHIP SERIES</b> .....	<b>4-1-1/4-1-2</b>
<b>Section 1 – Introduction</b> .....	<b>4-1-1/4-1-2</b>
<b>Section 2 – General Information</b> .....	<b>4-2-1</b>
Scope.....	4-2-1
Stages.....	4-2-1
Funding.....	4-2-1
Entry Fees.....	4-2-1
Competitors.....	4-2-1
Adult Coach.....	4-2-2
Cadet Coach.....	4-2-2
Equipment.....	4-2-2
Responsibilities for Implementation.....	4-2-2
Stage 1 – Local Unit Selection Championship.....	4-2-2
Stage 2 – Zone Championship.....	4-2-2
Stage 3 – Provincial/Territorial Championship.....	4-2-3
Stage 4 – National Championship.....	4-2-3
Matches.....	4-2-4
<b>Section 3 – Match Conditions</b> .....	<b>4-3-1</b>
Stage 1 – Local Unit Selection Championship.....	4-3-1
Stage 2 – Zone Championship.....	4-3-2
Stage 3 – Provincial/Territorial Championship.....	4-3-3
Stage 4 – National Championship.....	4-3-4
<b>Section 4 – Rules</b> .....	<b>4-4-1</b>
Foreword.....	4-4-1
1. General.....	4-4-2
2. Safety Regulations.....	4-4-3
3. Competitors – Eligibility Rules for Individuals and Teams.....	4-4-4



**TABLE OF CONTENTS (Cont)**

	<b>PAGE</b>
4. Meeting and Draws .....	4-4-6
5. Rifles .....	4-4-8
6. Equipment.....	4-4-9
7. Targets.....	4-4-11
8. Pellets .....	4-4-12
9. Facilities .....	4-4-13
10. Range Layout and Specifications .....	4-4-14
11. Coaching.....	4-4-17
12. Training .....	4-4-18
13. Competitors Relay Sequence .....	4-4-19
14. Range Commands .....	4-4-20
15. Competition Firing/Zeroing .....	4-4-21
16. Time Limits.....	4-4-23
17. Scoring.....	4-4-24
18. Results .....	4-4-26
19. Challenges .....	4-4-27
20. Protests.....	4-4-28
21. Infractions .....	4-4-29
22. Warnings, Penalties and Disqualifications.....	4-4-30
23. Jury .....	4-4-33
24. Supplementary Rules for Standing Match .....	4-4-35
<b>Annex A – Challenge Form/Formulaire de défi.....</b>	<b>4A-1/4A-2</b>
<b>Annex B – Protest Form/Formulaire de protêt.....</b>	<b>4B-1/4B-2</b>
<b>Annex C – Infraction Form/Formulaire d’infraction.....</b>	<b>4C-1/4C-2</b>
<b>Annex D – Challenge Register/Registre des défis.....</b>	<b>4D-1/4D-2</b>
<b>Annex E – Protest Register/Registre des protêts.....</b>	<b>4E-1/4E-2</b>
<b>Annex F – Infraction Register/Registre des infractions.....</b>	<b>4F-1/4F-2</b>
<b>GLOSSARY .....</b>	<b>GL-1</b>
<b>LIST OF ACRONYMS/ABBREVIATIONS .....</b>	<b>LA-1/LA-2</b>



# PART 1

---

## CANADIAN CADET MOVEMENT AIR RIFLE TRAINING MANUAL

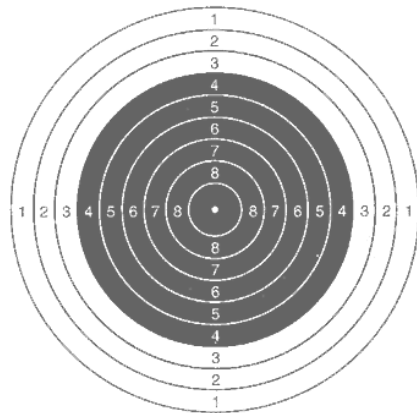
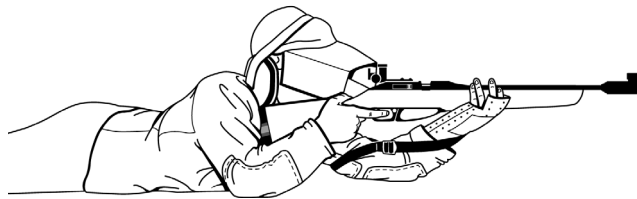



## TABLE OF CONTENTS

	<b>PAGE</b>
<b>PART 1 – AIR RIFLE TRAINING MANUAL .....</b>	<b>1-1-1/1-1-2</b>
<b>Section 1 – General.....</b>	<b>1-1-1/1-1-2</b>
<b>Section 2 – Cadet Marksmanship Programme.....</b>	<b>1-2-1</b>
2.1 Scope.....	1-2-1
2.2 Aim of Programme.....	1-2-1
2.3 Programme Objectives .....	1-2-1
2.4 Skill Development.....	1-2-1
2.5 Corps/Squadron Training.....	1-2-2
2.6 Summer Courses.....	1-2-2
<b>Section 3 – Safety .....</b>	<b>1-3-1</b>
3.1 Safety Precautions.....	1-3-1
3.2 Safety Regulations.....	1-3-3
3.3 Range Safety Officer Training .....	1-3-3
3.4 Lead Contamination: Disposal of Lead and Personal Hygiene .....	1-3-4
<b>Section 4 – The Daisy 853C Air Rifle and Pellets .....</b>	<b>1-4-1</b>
4.1 Characteristics .....	1-4-1
4.2 Parts.....	1-4-1
4.3 Air Rifle Pellets.....	1-4-3
<b>Section 5 – Marksmanship Techniques – Prone Position .....</b>	<b>1-5-1</b>
5.1 Proper Eye Usage.....	1-5-1
5.2 The Prone Position .....	1-5-2
5.3 Aiming .....	1-5-5
5.4 Breathing.....	1-5-8
5.5 Trigger Control.....	1-5-9
5.6 Follow-Through.....	1-5-10
5.7 Loading, Firing and Unloading.....	1-5-10
5.8 Immediate Action and Stoppages.....	1-5-13
5.9 Dry Firing .....	1-5-14
5.10 Use of the Sling.....	1-5-14
<b>Section 6 – Marksmanship Techniques – Standing Position.....</b>	<b>1-6-1</b>
6.1 The Standing Position.....	1-6-1
6.2 Aiming .....	1-6-5
6.3 Breathing.....	1-6-8
6.4 Trigger Control.....	1-6-9
6.5 Follow-through .....	1-6-10
6.6 Loading, Firing and Unloading.....	1-6-10
<b>Section 7 – Marksmanship Techniques – Kneeling Position .....</b>	<b>1-7-1</b>
7.1 The Kneeling Position.....	1-7-1
7.2 Use of the Sling.....	1-7-4
7.3 Aiming .....	1-7-6
7.4 Breathing.....	1-7-9
7.5 Trigger Control.....	1-7-9
7.6 Follow-Through.....	1-7-10
7.7 Loading, Firing and Unloading.....	1-7-10

## TABLE OF CONTENTS (Cont)

	<b>PAGE</b>
<b>Section 8 – Ranges and Range Procedures</b> .....	<b>1-8-1</b>
8.1 General Safety .....	1-8-1
8.2 Portable Range Set-up and Maintenance.....	1-8-1
8.3 Range Types.....	1-8-2
8.4 Range Commands and Procedures .....	1-8-3
<b>Section 9 – Targets and Scoring</b> .....	<b>1-9-1</b>
9.1 Targets.....	1-9-1
9.2 Scoring.....	1-9-1
<b>Section 10 – Cleaning</b> .....	<b>1-10-1</b>
10.1 Cleaning the Bore .....	1-10-1
10.2 Cleaning of Other Parts .....	1-10-2
<b>Section 11 – Maintenance</b> .....	<b>1-11-1</b>
11.1 Types of Maintenance.....	1-11-1
11.2 Disassembling the Rifle .....	1-11-2
11.3 Reassembling the Rifle.....	1-11-4
<b>Section 12 – Introduction to Coaching</b> .....	<b>1-12-1</b>
12.1 General .....	1-12-1
12.2 Duties.....	1-12-1
12.3 Firing Point Sequence.....	1-12-1
12.4 Competition Firing.....	1-12-2
12.5 Analysis of Common Errors .....	1-12-2
<b>Section 13 – Marksmanship Equipment</b> .....	<b>1-13-1</b>
13.1 General .....	1-13-1
13.2 Marksmanship Apparel .....	1-13-1
<b>Section 14 – Physical Training</b> .....	<b>1-14-1</b>
14.1 General .....	1-14-1
14.2 Warm-up Exercises to be Done Before Static Stretching.....	1-14-1
14.3 Static Stretching Exercises .....	1-14-2
14.4 Diet.....	1-14-4
14.5 Relaxation Techniques .....	1-14-4
<b>Section 15 – Mental Training</b> .....	<b>1-15-1/1-15-2</b>
15.1 General .....	1-15-1/1-15-2
15.2 Mental Imagery .....	1-15-1/1-15-2
<b>Section 16 – Training Plan &amp; Marksmanship Diary</b> .....	<b>1-16-1</b>
16.1 Goals.....	1-16-1
16.2 Training Plan.....	1-16-1
16.3 Marksmanship Diary .....	1-16-2
16.4 Sample Diary Sheet.....	1-16-2

**TABLE OF CONTENTS (Cont)**

	<b>PAGE</b>
<b>Annex A – Development of a Marksmanship Team.....</b>	<b>1A-1/1A-2</b>
<b>Annex B – Air Rifle Grouping Template .....</b>	<b>1B-1/1B-2</b>
<b>Annex C – Marksmanship Reference Material .....</b>	<b>1C-1</b>
<b>PART 2 – AIR RIFLE TRAINING AIDE-MÉMOIRE .....</b>	<b>2-1</b>
<b>PART 3 – UNIT MARKSMANSHIP TRAINING PLAN.....</b>	<b>3-1</b>
<b>PART 4 – MARKSMANSHIP CHAMPIONSHIP SERIES .....</b>	<b>4-1-1/4-1-2</b>





**PART 1**  
**AIR RIFLE TRAINING MANUAL**  
**SECTION 1**  
**GENERAL**

The purpose of this training manual is to consolidate, in handy reference form, information on air rifle firing. This manual is designed to educate all persons within the Canadian Cadet Movement (CCM) about the air rifle and to ensure that all cadet corps/squadrons have an equal opportunity to learn marksmanship skills. It also serves as a technical reference guide for coaches.

This manual has the following aims:

- a. To inform cadet corps/squadrons about the air rifle marksmanship programme;
- b. To improve cadets skill level in air rifle marksmanship;
- c. To assist Cadet Instructor Cadre (CIC) officers and civilian instructors (CI) in air rifle range set-up, range procedures, target scoring and coaching techniques;
- d. To identify proper cleaning methods, maintenance, and repair of the air rifle; and
- e. To introduce the implementation of physical and mental training exercises.

This manual does not take precedence over any Cadet Administrative Training Order (CATO), Canadian Forces Technical Order (CFTO), Canadian Forces Administrative Order (CFAO), or any other Department of National Defence (DND) regulation or order.

When an item refers to a right-handed marksman, the reverse of that item refers to a left-handed marksman.

References to the directions **left** and **right** are described from the perspective of a marksman that is in the firing position.

Suggestions for improvements to this document are encouraged and may be submitted to the Staff Officer responsible for marksmanship within each Area/Region.



## SECTION 2

### CADET MARKSMANSHIP PROGRAMME

#### 2.1 SCOPE

A recent survey conducted by the Directorate of Cadets confirmed that marksmanship is one of the most popular and appealing aspects of tri-service cadet training. The marksmanship programme places a greater emphasis on recreational marksmanship as a sport. Self-discipline, acceptance of responsibility and respect for firearms are but a few of the many positive benefits derived from this cadet programme.

The new programme is self-sustaining in that it allows all cadet corps/squadrons weekly access to an affordable, recreational and competitive marksmanship programme. It also provides Cadet Summer Training Centres with the resources and staff required to conduct marksmanship training.

#### 2.2 AIM OF PROGRAMME

The aim of the National Cadet Marksmanship Programme is to develop cadets' interest in marksmanship while promoting the safe and proficient use of firearms for sport and recreational purposes. Such activities are also valuable in helping cadet corps/squadrons achieve other aspects of the cadet programme related to leadership, citizenship and sensible living. Cadet rifle marksmanship, by being both challenging and fun, can also enhance the retention of cadets.

#### 2.3 PROGRAMME OBJECTIVES

The objectives of the National Cadet Marksmanship Programme are:

- a. To promote firearms safety;
- b. To develop marksmanship skills;
- c. To stimulate and maintain an interest in the CCM;
- d. To train CIC officers, CI and senior cadets in how to conduct firearms training; and
- e. To produce CIC and cadet coaches.

#### 2.4 SKILL DEVELOPMENT

Within each marksmanship discipline (air rifle, smallbore rifle and fullbore rifle), skill progression is determined through a system of training levels referred to as Training Components. The three (3) training components available in the air rifle discipline are:

- a. Familiarization;
- b. Classification; and
- c. Competition.

## **2.5 CORPS/SQUADRON TRAINING**

Cadet corps/squadrons are responsible for conducting the training at the Corps/Squadron level. Training sessions can be conducted by cadet unit personnel (cadets, CIC officers, Civilian Instructors (CI) or volunteers) or in conjunction with various civilian marksmanship organizations.

### **NOTE**

A qualified air rifle Range Safety Officer (RSO) must be present at all times when training is conducted on the range. This manual will serve as a guide for this type of training, but will not compensate for formal training dispensed by the Regional Cadet Instructors School (RCIS).

## **2.6 SUMMER COURSES**

Most Cadet Summer Training Centres conduct marksmanship, biathlon and coach training with the Daisy 853C air rifle.

## SECTION 3

### SAFETY

Firearms safety is the number one priority on and off the range so everyone must do their part to prevent accidents. In this sport, the majority of incidents are caused by the ignorance of proper rifle operating procedures or by mishandling. Marksmanship can be an exciting sport when done safely.

#### 3.1 SAFETY PRECAUTIONS

##### 3.1.1 Safety Catch and Security Measures

The safety catch is a mechanism that, once engaged, prevents a rifle from firing by locking its trigger into place. It is located just in front of the trigger, on the trigger guard.

To engage the safety catch (ON) it must be pushed towards the right so no red can be seen. To fire, the safety catch must be pushed towards the left in the OFF position and a red mark must be seen on it. For maximum security, it is recommended that the safety catch be kept engaged until the rifle is ready for firing.

**Remember: Safety Catch**

**ON = no red (safe)  
OFF = red (ready)**

##### 3.1.2 Safety Rod

To ensure that air rifles are not removed from the firing point or stored with a pellet in the chamber or barrel, a safety rod is to be inserted in the barrel from the muzzle end. It consists of two (2) sections of wooden dowling joined together in a "T" shape (it can also be made of other materials). Dimensions are detailed in the diagram below. The tip of the safety rod is to be coloured red using an ink marker.

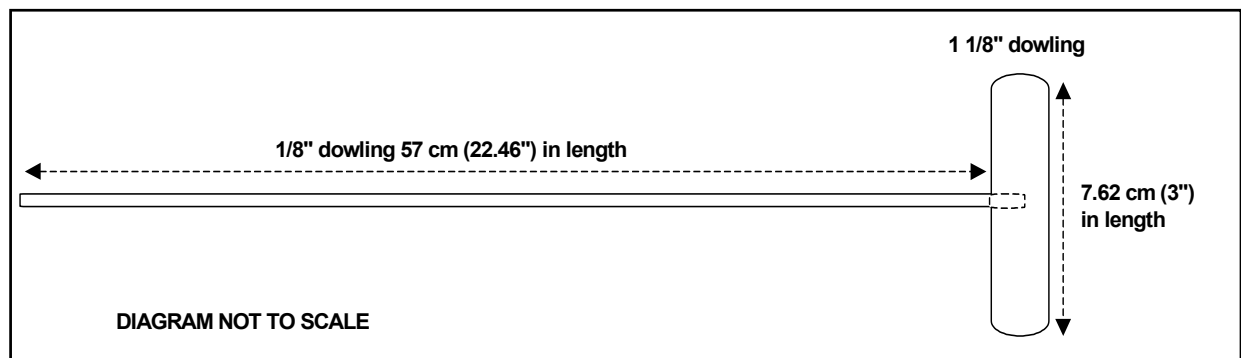

### 3.1.3 “Safe Rifle Status”

When not being handled on the range or in a training environment, the air rifle must be in a safe status. The following options denote various “safe rifle status”:

#### **Option One: In the rifle case**

- a. Safety catch is ON;
- b. Bolt is forward;
- c. Action is not cocked;
- d. Safety rod is in the case but not in the barrel; and
- e. Pump lever is partially open (5-8 cm).

#### **Option Two: On the firing line**

- a. Safety catch is ON;
- b. Bolt is to the rear; and
- c. Pump lever is partially open.

#### **Option Three: Not on the firing line**

- a. Safety catch is ON;
- b. Bolt is to the rear;
- c. Safety rod is in barrel (visible in the feed track); and
- d. Pump lever is partially open.

### 3.1.4 Removing a Rifle from the Case

The rifle case should be clearly marked on the outside with an arrow, indicating in what direction the rifle inside is pointing. This will ensure that when the case is opened, the rifle is pointing in a safe direction. The following steps must be followed in removing a rifle from its case:

- a. Place the rifle case on a flat surface and ensure the arrow is pointing in a safe direction;
- b. Open the case;
- c. Cock the action (leave the bolt to the rear);
- d. Confirm that the safety catch is ON;
- e. Confirm that the pumping lever is partially open;
- f. Slide the safety rod in the barrel towards the bolt until it can be seen in the feed track;
- g. Remove the rifle from the case; and
- h. Remove the safety rod if you are on the firing line.

### 3.1.5 Individual Safety Precautions

Upon receiving a rifle or when the “safe rifle status” is uncertain, individual safety precautions should be done to confirm that the rifle is safe. An individual must ensure that:

- a. The bolt is open fully to the rear;
- b. The safety catch is in the ON position;
- c. The pump lever is partially open; and
- d. A safety rod is inserted in the barrel.

#### NOTES

1. If an individual is taking a position on the firing line and an instructor has pre-positioned a rifle, a safety rod is not required.
2. Instructors/coaches must ensure that they complete individual safety precautions on all rifles to be used for instruction or firing on the range, before allowing cadets to handle the rifles as well as before removing rifles from the firing line.

### 3.2 SAFETY REGULATIONS

Safety regulations are all common sense and are easy to apply when people understand why they are necessary to help prevent accidents.

The following is a list of essential safety regulations:

- a. A rifle should always be treated as if it is loaded and be considered dangerous unless proven otherwise;
- b. A rifle should never be pointed at anyone;
- c. A rifle should always point in a safe direction. In the firing position, it should always point down range toward the targets;
- d. A rifle should be held in the vertical position with the muzzle pointing up when transporting it to and from the firing point and/or range;
- e. Fingers should be kept off the trigger unless the marksman is ready to fire;
- f. Hearing protectors may be worn when firing an air rifle; and
- g. The wearing of safety glasses or shatterproof eyeglasses is mandatory when firing. The wearing of specialized glasses is permitted **only** if the lens completely covers the aiming eye and a blinder which provides appropriate protection is installed to cover the non-aiming eye. All range staff must also wear safety glasses.

### 3.3 RANGE SAFETY OFFICER TRAINING

All CIC officers who are interested in conducting air rifle live firing practices must have successfully completed the Air Rifle RSO Course. This course deals with range safety criteria, conducting a range practice, carrying out range personnel taskings, exercise planning and preparation, and range conduct (set-up, briefing, firing practice, after firing).

### **3.4 LEAD CONTAMINATION: DISPOSAL OF LEAD AND PERSONAL HYGIENE**

Although there have only been a few authenticated cases of lead poisoning from rifle firing, all air rifle marksmen should take precautions to reduce any potential for lead contamination. Firearms that use cartridges generate most of their contaminants as a result of burning propellants and primers. Obviously this is not a consideration in this discipline. However, each time someone handles pellets, a small trace of lead is left on their hands and can be transferred to other parts of their body or to food. Over a period of time, this contact could increase lead levels in the body. It is therefore recommended that hands be washed thoroughly following all contact with pellets.

Spent pellets are regarded as hazardous waste and must be disposed of in accordance with local regulations.



## SECTION 4

### THE DAISY 853C AIR RIFLE AND PELLETS

#### 4.1 CHARACTERISTICS

- a. **Action:** Single pump pneumatic, straight pull-bolt;
- b. **Total length:** 97.8 cm;
- c. **Total weight:** 2.5 kg;
- d. **Calibre:** 0.177 calibre (4.5 mm);
- e. **Front sight:** Global type with interchangeable aperture inserts;
- f. **Rear sight:** Fully adjustable peep rear sight with micrometer click adjustment;
- g. **Barrel:** Lothar Walther rifled high-grade steel barrel with weight: crowned 12 lands and grooves, right hand twist. Precision bore sized for match pellets. Approximate length 53.1 cm;
- h. **Muzzle velocity:** 150.8 metres per second;
- i. **Maximum range:** 235.4 metres;
- j. **Loading:** Single or auto indexing five (5) pellet clip;
- k. **Stock:** Full-length, sporter-styled hardwood with adjustable length;
- l. **Sling:** Adjustable competition web;
- m. **Trigger weight:** Minimum 3.5 pounds;
- n. **Chamber:** Open loading and made of steel;
- o. **Safety:** Manual crossbolt trigger block with red indicator; and
- p. **Pumping force:** 20 lbf.

#### 4.2 PARTS

- a. **Butt Plate (End of the butt).** It is part of the rifle directly in contact with the marksman's shoulder. It is adjustable in length with the addition of butt spacers. When fitted properly, the butt plate aids in achieving a snug fit and a consistent placement of the rifle into the shoulder;
- b. **Spacers.** Plastic inserts that can be added or removed from the butt plate to vary its length. To add or take away butt spacers, simply use a Phillips screwdriver to loosen the butt plate and slide in/out the amount of spacers desired;
- c. **Small of the Butt (Pistol Grip).** Curved area directly behind the trigger guard where the hand controlling the trigger grips the rifle;
- d. **Stock.** Complete wooden portion of the rifle (from the butt plate end forward);

- e. **Fore End (of the Stock).** Wooden portion of the stock from the trigger guard forward, in which the barrel and the rifle mechanism are encased;
- f. **Sling.** Links the rifle to the marksman's arm and supports most of the weight of the rifle. It is a web sling made of nylon. One end attaches to the sling bracket and the other to the upper arm;
- g. **Sling Bracket (Handstop).** Adjustable metal clasp attached to the forestock and where the sling is fixed to the rifle. It also acts as a handstop (device used to rest the left hand to prevent it from moving);
- h. **Trigger.** Movable device that releases a spring and sets off the rifle mechanism. This rifle has a single stage trigger that cannot be adjusted for weight;
- i. **Trigger Guard.** Metal area that surrounds and protects the trigger;
- j. **Safety Catch.** This is a mechanism that, once engaged, prevents the rifle from firing by locking the trigger in place. It is a cross bolt type device located on the trigger guard. The black side indicates that the rifle is unable to fire; the red side indicates the rifle is ready to fire. It should be ON (no red) at all times, except when firing;
- k. **Bolt.** Metal lever used for opening or closing the rifle mechanism. It must be in the closed position in order to fire. For maximum safety when not firing, the bolt should be kept open;

#### NOTE

When a rifle is stored the bolt should be forward and the action must not be cocked.

- l. **Pump Lever.** Metal lever used to compress the air required to fire the pellet. Whenever the rifle is in a "safe rifle status", the pump lever should be left partially open;
- m. **Sight System**
  - (1) **Front Sight.** Global front sight that uses aperture inserts; and
  - (2) **Rear Sight.** Micrometer sight adjustable for windage and elevation. It is easily attached to the metal rail located above the action. This rail allows you to slide the sight forward or backward in order to maintain proper eye relief. The sight is tightened using a small flat-blade screwdriver;
- n. **Muzzle.** Front end of the barrel equipped with attachable barrel weight;
- o. **Barrel with Barrel Weight.** Steel tube extending from the muzzle to the chamber, through which the pellet travels. The barrel weight ensures that the rifle's weight is evenly distributed and that the rifle's balance is maintained;
- p. **Bore.** Interior of the barrel which has spiral grooves cut into it. The lands are the ridges of metal between the grooves. Together, the grooves and lands are called rifling;
- q. **Feed Track.** Delicate area where the pellet is inserted manually onto the single pellet adapter or with a five (5) pellet clip;
- r. **Single Pellet Adapter.** Plastic clip that aids in placing a pellet in the chamber;
- s. **Five (5) Pellet Clip.** Plastic clip that holds a maximum of five (5) pellets and used to place the pellets in the chamber; and

- t. **Chamber.** Place where the pellet is held before firing.

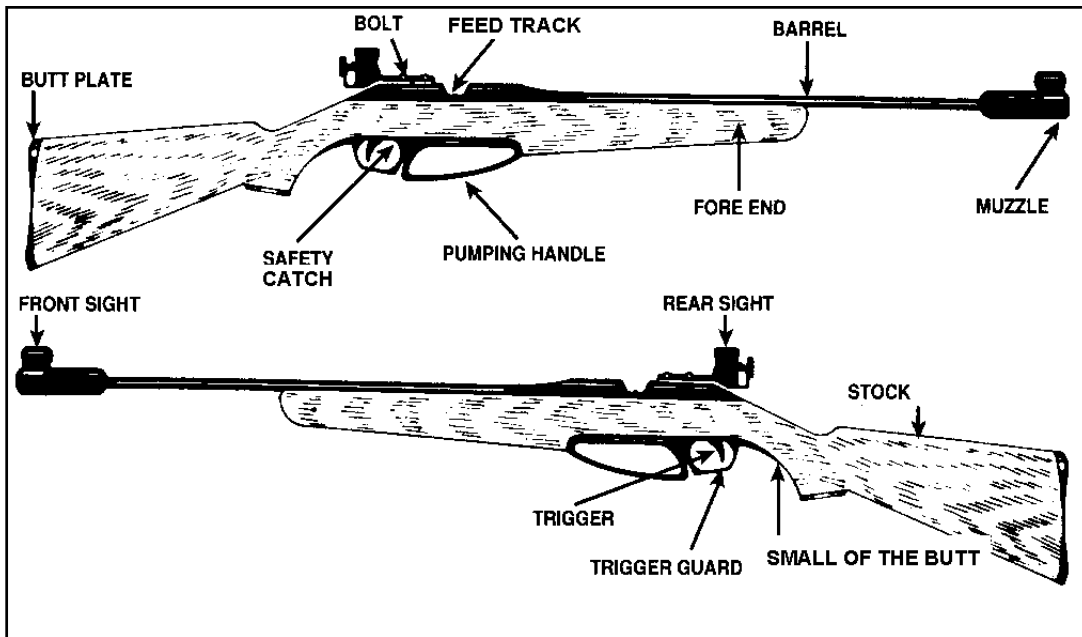

## 4.3 AIR RIFLE PELLETS

### 4.3.1 General

Air rifles are very sensitive to variations in pellet design and construction. The relationship between pellet fit in the breech and response to peak pressure during firing is critical in obtaining optimal pellet performance. Extensive testing to confirm performance and accuracy was conducted prior to adopting the current air rifle pellet. Additional testing on an as required basis will be conducted to ensure that the pellets in service provide an optimal cost-benefit performance for marksmanship training and competition.

### 4.3.2 Pellet Design and Type

- a. **Diabolo.** The most popular pellet design is the hourglass-shaped air rifle pellet, commonly referred to as the diabolo. The term is derived from the pellet's resemblance to the spool-shaped device used in an ancient Greek throwing game called diabolo. The "waisted" design of the pellet minimizes the friction between the pellet and the rifling. The thin hollow base (or skirt) expands during its travel down the bore to grip the rifling grooves and to establish an effective air seal. The pellet head is slightly smaller in diameter than the skirt and simply rides the rifle barrel lands. In a well-designed diabolo pellet, most of the pellet weight is forward of the skirt in the head of the pellet. This gives the pellet maximum stability in flight – similar in concept to a badminton shuttle.
- b. **Wadcutter.** There are a number of variations on the basic diabolo design. These variations are based upon the intended use of the pellet. For marksmanship and competition training, the wadcutter pellet is used. This flatheaded pellet is designed for cutting neat, clean holes in paper, which allows for accurate, precise scoring of the target. Only diabolo-design wadcutter pellets supplied by the Canadian Forces (CF) are authorized for use in cadet air rifles. Despite its non-aerodynamic appearance, the wadcutter pellet's ballistics are not affected by its flathead design at distances less than 15 metres. In fact, in many instances the wadcutter has better accuracy at short ranges, such as ten metres. Since all cadet training and competitions use a ten-metre range, the flathead pellet design is not a factor in ballistic performance or accuracy.

### **4.3.3 Factors Affecting Ballistics**

The most important factor affecting the performance of a pellet is the uniformity of its hollow base. The skirt area has a thin wall that may be easily deformed due to the softness of the pellet head. These deformities affect the pellet's ability to grip the rifle and the balance of air pressure on the pellet. Consequently, optimal muzzle velocity and accuracy will not be achieved.

A simple test to confirm whether or not a pellet is deformed is to roll it on a smooth surface and observe whether or not it rolls smoothly. If the pellet wobbles or jerks, it is out of balance or deformed, and this will decrease its accuracy.

## SECTION 5

### MARKSMANSHIP TECHNIQUES – PRONE POSITION

This section deals with all the marksmanship skills required for proper firing. They can be divided into five principles as follows:

- a. Position;
- b. Holding;
- c. Breathing;
- d. Aiming; and
- e. Trigger Control.

These principles must all function in harmony. Improving one while not working on another will not provide very good results in the long run. Perfecting these principles takes time and concentration, cadets should remember – **PRACTICE MAKES PERFECT!**

#### 5.1 PROPER EYE USAGE

##### 5.1.1 Selecting the Master Eye

Everyone has a master (or dominant) eye which is stronger than the other one. This is the eye to be used when aiming. The master eye is the brain's primary source for the visual image of what we see. The non-master eye is used primarily for depth perception or sense of direction.

The master eye must be determined before individuals begin firing. It should be noted that the master eye is not always on the same side of the body as the writing hand.

To determine the master eye, cadets should follow the steps listed below:

- a. Select a small object (i.e., the corner of a wall) at least five (5) metres away;
- b. Face the object and extend both arms in front of their body towards the object;
- c. With both eyes open, form a small, tight opening around the object with their thumbs and index fingers;
- d. Look at the object through the opening with both eyes open and draw both hands back toward their face. Ensure that the object remains centred through the opening of their thumbs and index fingers; and
- e. They should now be looking through the opening at the object with one single eye – the stronger of the two. This is their master eye. They should always use this eye for aiming when they fire.

If the master eye is on the opposite side of the body than the writing hand, it is advisable that cadets change shoulders and fire with their opposite hand and use their master eye. This should not however be done at the expense of the cadet's comfort.

#### NOTE

If changing shoulders in order to accommodate the master eye proves uncomfortable, cadets should fire the way they feel most comfortable.

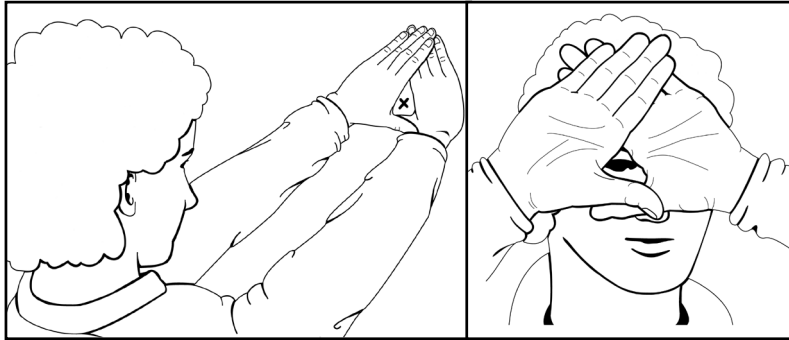

### 5.1.2 Firing with Both Eyes Open

Cadets should always fire with both eyes open. Eyes are constantly working together. If one is closed, the other will have to strain and the individual's vision will be affected. If cadets have difficulty focusing, the use of a blinder in front of the non-aiming eye will help prevent squinting and eye fatigue.

Cutting a piece of plastic from a windshield washer fluid jug or any other similar type of container can easily make a blinder. A good blinder should be translucent (plastic or paper) so that images are blocked even though light can penetrate it. It should be easily attachable to the rear sight or to the cadet's glasses.

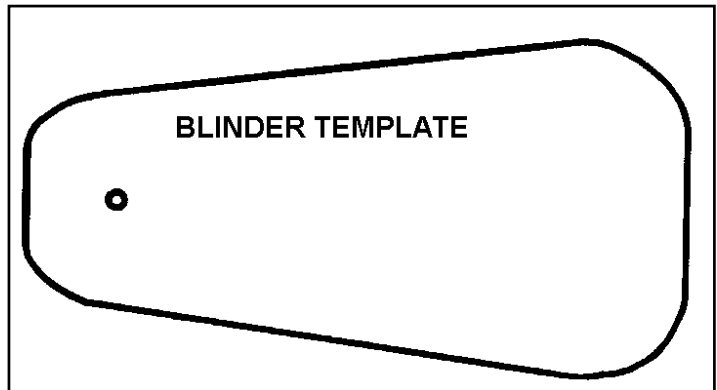

### 5.1.3 Avoiding Fixed Vision

If the marksman's vision is fixed on one object, such as a target bullseye, for more than a few seconds, the image of the bull will be burned in their mind and a "ghost" image of the bull will be seen when glancing to the side. It is especially important for cadets to avoid this fixed vision, because it results in a loss of visual perception and can greatly hinder their performance. To avoid fixed vision, cadets need only to blink or slightly shift their vision every four (4) or five (5) seconds.

## 5.2 THE PRONE POSITION

### 5.2.1 General

Obtaining a good prone position is one of the most, if not the most important principle of marksmanship. A good prone position helps to maintain comfort and stability during the firing session. Although an excellent position will not guarantee an excellent performance, a poor position can almost assure a substantially negative effect on results.

### 5.2.2 Rifle Rests

An excellent way to practice the marksmanship skills required by a cadet is to use a rifle rest such as a sandbag, a scope stand or a pile of books. This allows the cadet to perfect and to understand their marksmanship skills while the rifle is held steady. Once these skills are learned, the rifle rest should be removed and replaced by the sling.



### 5.2.3 Obtaining a Good Position

The objective of a good position is to obtain a stable, uniform platform in the most efficient way possible allowing holding and aiming to be achieved with as little movement and muscular tension as possible.

The position should be:

- a. Natural;
- b. Without strain;
- c. Comfortable;
- d. Stable;
- e. As such that body weight is equally distributed; and
- f. Consistent throughout the relay.

### 5.2.4 Characteristics of a Good Position

The characteristics of a good prone position are as follows:

- a. The body should form a 5-20° angle to the line of sight;
- b. The body should not be twisted and the spine should be straight;
- c. The left leg should be parallel with the spine;
- d. The right foot should turn out and point to the right; the left foot should be straight behind on the toe or pointed to the right according to the comfort of the individual;
- e. The right knee should be brought up so that the thigh forms an angle between 30-45° with the left leg. The right knee should be bent in order to improve stability. This causes the body to roll slightly to the left, raising the diaphragm off the ground, thus enhancing breathing. As the chest is also raised off the ground, body movements caused by normal heartbeat are minimized;
- f. The left elbow should be positioned slightly to the left of the rifle. It should not be positioned directly under it or stability will be affected. In order to maintain consistency throughout the relay, the left elbow should not be moved, even while pumping the rifle;

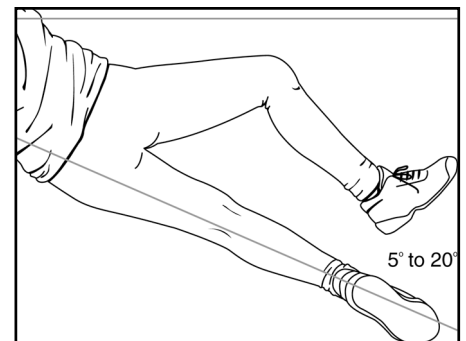
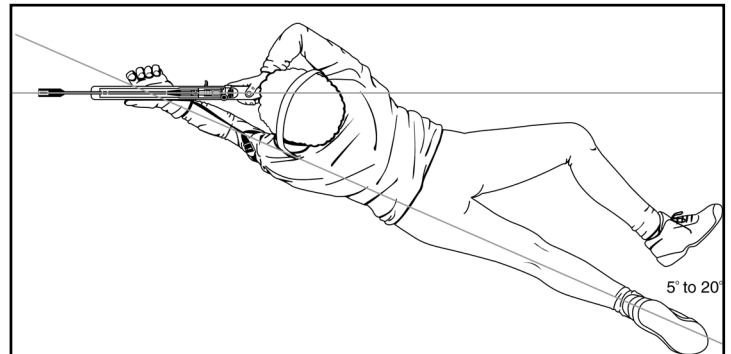

- g. In accordance with the CCM Marksmanship Championship Series Rules, the left forearm must form at least an angle of 30° with the ground;

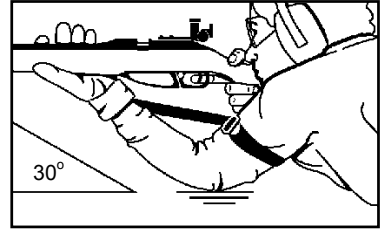

- h. The left hand should rest in the sling and firmly against the sling swivel and the fingers should not grip the fore end of the stock. The hand should be relaxed and the rifle should rest in the palm of the hand;

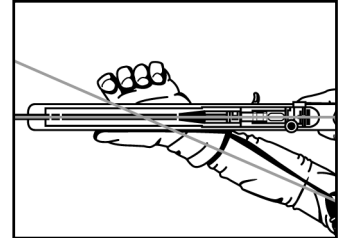

- i. Once a good position is established, the right hand should grip the small of the butt with constant pressure. The force applied by the right hand should never have to support the rifle. If a distinct pressure is necessary in order to keep the rifle in place, some aspect of the position will have to be changed;

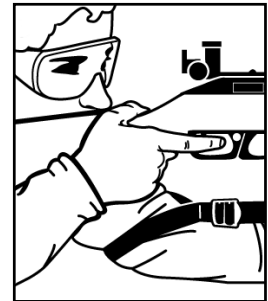

- j. The right thumb should be placed on the stock directly behind the rear sight or around the small of the butt;

- k. The position of the right elbow is established after the rest of the body is in place. After placing the right hand on the small of the butt, the right elbow should rest naturally where it falls and feels comfortable. However, the elbow should not be too close or too far from the rifle and it should only bear a small amount of pressure;



- l. The shoulders should be straight and form right angles with the spine;

- m. The butt plate is kept firmly in the hollow of the right shoulder. In order to ensure that the butt plate is always placed in the same spot, cadets should grasp it with their thumb and forefinger and place it in their shoulder for each and every shot. The right elbow will naturally fall in the same spot throughout the relay; and

- n. The head rests comfortably on the butt and remains straight. There should be a minimal distance of approximately five (5) cm between the right eye and the rear sight (known as eye relief). This distance should remain constant throughout the relay. When the face is placed on the butt, the cadet should be looking directly through the sights. If this is not the case, their position should be modified.

To ensure positive results, the aforementioned points should be repeated for each shot. The elbows should always be in the same place, the head should exert the same amount of pressure on the rifle, the eye relief should remain constant and the right knee should always be in the same position. If any of these points does not feel right or if cadets find their position uncomfortable, they should readjust it until it is perfect.

### 5.2.5 Adopting the Prone Position Using a Rifle Rest

The following steps should be adhered to when adopting the prone position using a rifle rest:

- a. Lay down to the left of their rifle;
- b. Place the left elbow on the ground;



- c. Pick up the rifle;
- d. Lay the rifle on the rest;
- e. Get into a comfortable position while keeping the rifle on the rest;
- f. Place the butt plate into the right shoulder;
- g. Rest their cheek on the butt;
- h. Place the right elbow on the ground;
- i. Adjust the height of the rest; and
- j. Adjust the length of the butt using spacers.

### 5.3 AIMING

#### 5.3.1 Front Sight

The front sight on the Daisy 853C is hooded. This is a feature found on most competition rifles to shield the front sight aperture from overhead or side light. The hood is formed by a short tube and is supported by a slender base which is attached to the rifle barrel.

The front aperture should be selected to provide the best sight picture. There are three (3) front sight inserts that come with the Daisy 853C: one (1) post sight and two (2) aperture-type sights. The post sight should not be used in cadet air rifle marksmanship. A good sized aperture should appear 1-1/2 times bigger than the aiming mark, as seen in paragraph 5.3.5.

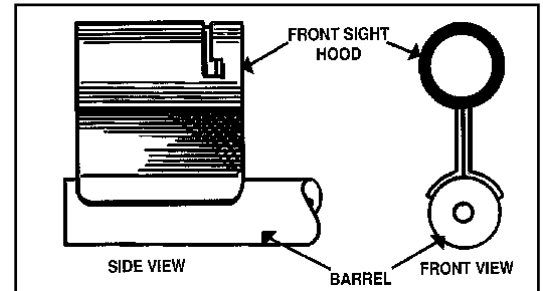

#### 5.3.2 Rear Sight

The part of the rear sight that is looked through is the peep sight. It is a small disk about the size of a penny with a small hole in it.

The rear sight has two (2) knobs that are used to move the point of impact of the shot. The **elevation** knob (on top) moves the point of impact up or down on the target. The **windage** knob (on the right side) moves the point of impact left or right. The adjustment of the knobs is measured in clicks that can be felt as the knob is turned.

It takes three (3) clicks to move the point of impact approximately one pellet width. At a distance of ten (10) metres, each click equals approximately a 1.219 mm shift of the point of impact.

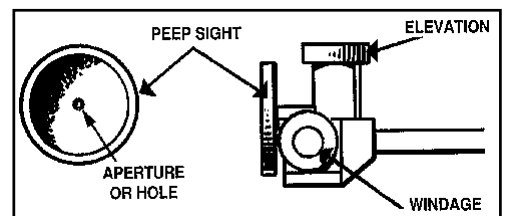

- a. **Elevation.** To lower the point of impact, turn the elevation knob counterclockwise (to the left). To raise the point of impact, turn the elevation knob clockwise (to the right), as per the arrow and the word "UP".
- b. **Windage.** To move the point of impact to the left, turn the windage knob counterclockwise (to the left). To move the point of impact to the right, turn the windage knob clockwise (to the right), as per the arrow and the letter "R".

#### **Remember: Sight Adjustment**

**UP & RIGHT = clockwise**  
**DOWN & LEFT = counterclockwise**

On scoring targets no initial sight adjustment should be made until cadets have fired at least a five (5) shot group. They should also avoid changing their sights after each shot (this is called “chasing the shot”) since centering the group is the main goal in marksmanship.

- c. **Backlash.** Sights are adjusted by turning a knob that is actually the head of a bolt. This bolt passes through a mating nut that holds the rear sight aperture. As the knob is turned, the nut moves accordingly, and the rear sight slides in a guide. As in all screw threads, there must be clearance between the threads in this nut and bolt combination, and this results in “backlash”, which must be taken up before the nut actually moves.

#### NOTE

To compensate for this, **always make the final sight adjustment by turning the adjusting knob clockwise.** For example, there is no problem if the sight adjustment requires turning the knob clockwise. However, if the sight adjustment requires turning the knob counterclockwise, it should be turned counterclockwise two (2) clicks farther than required, and **then** turned two (2) clicks clockwise.

### 5.3.3 Proper Head Position

The head should be kept as close as possible to a position which allows the eyes to look straight forward from the eye socket. To illustrate the penalty for not doing this, cadets should try moving their eyes as far in one direction as they can (up, down, right or left) in the eye socket. Instantly they will feel a strain on their eyes. The closer they can position their head so that their eyes are looking straight forward from the eye socket, the more relaxed their eye muscles will be. It is perfectly normal to tilt the head forward slightly, but cadets must resist allowing it to tilt to the left or right as this affects their sense of balance.

### 5.3.4 Eye Relief

Eye relief is the distance between the eye and the rear sight. Depending on an individual's build and position, this distance is usually 5 to 15 cm. This distance may have to be reduced slightly due to the size of the Daisy 853C rifle. Cadets should strive to achieve an eye relief that is comfortable, natural, and allows them to see a circle of light around the front sight as they look through the rear sight. It is important for them to maintain the same eye relief from shot to shot and to find an eye relief that allows them to keep their head as erect as possible during the firing process. If they get closer to the sight than 5 cm, the line of white around the front sight becomes larger and more difficult to keep aligned.

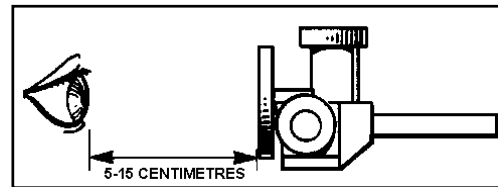

### 5.3.5 Sight Alignment

Sight alignment is the most critical element of the aiming process. It is the alignment of the eye, the rear sight, and the front sight.

When cadets bring their eye 5 to 15 cm from the rear sight, they will find that the small hole is large enough to look through and see all of the front sight. This is what they see when they have achieved proper sight alignment.

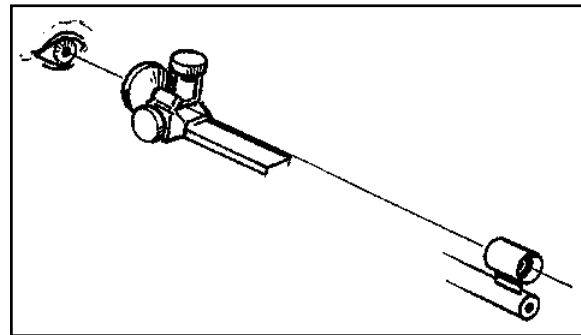

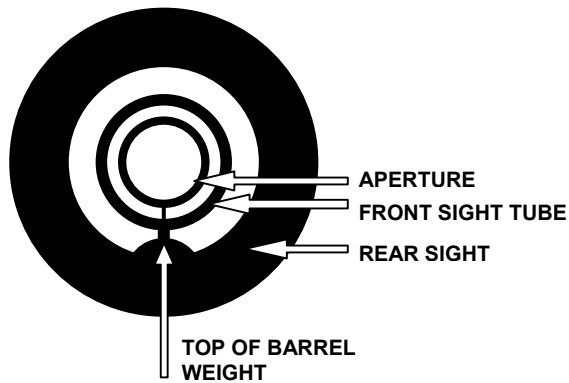

Proper sight alignment is a matter of centering the front sight hood in the rear sight. The hood will not quite fill the rear sight and cadets will be able to see light around the outside of the hood; we call this a “line of white”.

#### NOTE

To keep the sights properly aligned, the line of white must be equal on all sides.

### 5.3.6 Sight Picture

To obtain a proper sight picture, a bullseye is simply added to the innermost ring. The goal during the aiming process is to maintain proper sight alignment while keeping the bull centered in the front sight.

The ultimate goal is to have all the circles in perfect alignment, but even some expert marksmen can only reach this perfection and hold it for no more than a few seconds at a time.

To a cadet who is concentrating on sight alignment, any movement of the rifle while aiming will make it appear as though the bull is moving around within the front sight aperture. This apparent movement of the bull should not overly concern the beginning individual.

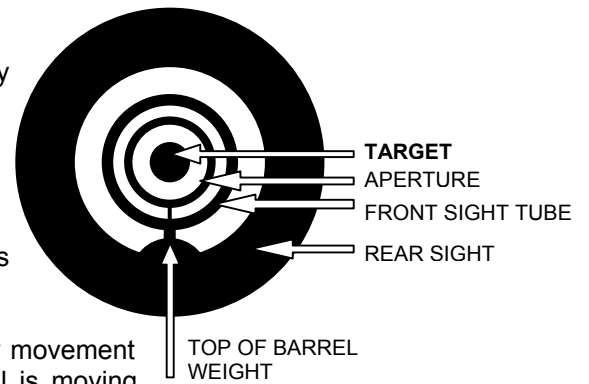

Cadets must constantly strive to maintain proper sight alignment, while obtaining a sight picture. It is the most critical element of the aiming process.

### 5.3.7 Natural Alignment

Natural alignment is obtained when the rifle can be perfectly aimed at the target without being muscled into achieving this. In a comfortable position, the cadet does not force the air rifle to point to the target, which would create muscular tension. Proper alignment will also prevent “drifting” of the group during a course of fire.

After establishing a comfortable position, the cadet must now make sure that their body and rifle are directly aligned with the target. In order to understand the notion of natural alignment it is important to remember that the rifle is supported by the bones and not the muscles.

In order to ensure that the position is directly in line with the target, cadets should follow these steps:

- a. Assume the prone position, look through the sights and acquire a proper sight picture;
- b. Close their eyes, take several normal breaths and relax into a comfortable position;
- c. Once comfortable, look through the sights again. If they are perfectly centered with the target, proceed with firing;
- d. If they are not directly centered with the target, they must re-orient their position slightly. To do this, they will need to pivot their body on the left elbow, more precisely:
  - (1) if they are aiming too far to the left, they move their lower body slightly to the left;

- (2) if they are aiming too far the right, they move their lower body slightly to the right;
  - (3) if they are aiming too low, they move their lower body slightly back (if this does not work, they can tighten their sling); and
  - (4) if they are aiming too high, they move their lower body slightly forward (if this does not work, they can loosen their sling);
- e. Close their eyes and do a final check on their alignment. If they are still not perfectly aligned, they must start over! They must remember to never move their left elbow when they shift their position around.

Again, it is essential that cadets use their bones to support the rifle, so that their muscles remain relaxed. Under no circumstances should they use their muscles to change the point of aim by moving the rifle from side to side. If they do a proper follow-through, the rifle will automatically return to the point of aim.

It is also important that cadets check their alignment during their course of fire to ensure their position has not shifted. Note also that “warmed” muscle groups react differently from “cold” muscle groups. It is important to allow for a proper warm-up prior to firing. A brief warm-up exercise is described in Section 12.

### **5.3.8 Aiming Process**

After establishing their natural alignment, cadets are now ready to move along to the actual sequence of aiming. The aiming process is as follows:

- a. Get into a comfortable position;
- b. Make sure the alignment with the target is good;
- c. Verify the size of the front aperture; and
- d. Follow the procedures described in paragraphs 5.3.5 and 5.3.6.

## **5.4 BREATHING**

### **5.4.1 Importance of Breathing**

Breathing supplies the blood stream with the oxygen necessary for all body functions and to eliminate waste elements (such as carbon dioxide) from the blood. Once a stable position is established, cadets must integrate the principles of breathing. While breathing, the oxygen inhaled is used to supply muscles with energy, ensuring optimal potential of these muscles. This includes the muscles that are involved in the position, as well as the muscles in the eyes.

For maximum stability when firing, cadets will have to stop breathing for a few seconds. It is of the utmost importance that they do not hold their breath for more than five (5) to seven (7) seconds, as the tension will increase in their chest muscles and reduce stability. After this period of time, muscles start to lack oxygen and will quiver and eyesight will be negatively affected. This becomes evident if the cadet’s perception of the aiming mark goes from black to gray.

## 5.4.2 The Breathing Cycle

In order to achieve a proper breathing sequence, the information in the following graph should be adhered to:

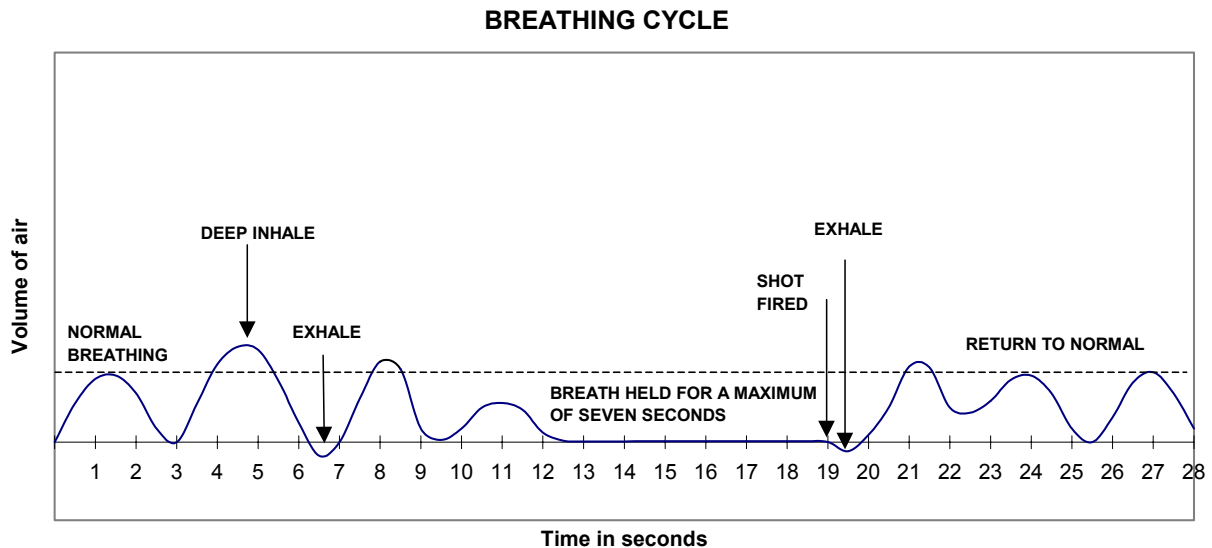

Breathing should be relaxed and normal as cadets establish a sight picture. Then, they should inhale and exhale deeply, take another deep inhale, exhale normally, and completely release their chest muscles and hold their breath. After the shot, a small exhale is followed by normal breathing, and the cycle is repeated.

Cadets should use breathing as a way to confirm that the rifle is moving up and down in a perfect vertical manner and that the rifle is not canted. Also, when breathing in and out, cadets can visually confirm that they are aiming on the proper diagram.

Again, it is important for cadets not to fire if they feel they want to breathe again. Their shot will not be perfect and their end result will be affected. They should not be afraid to restart their entire sequence, as this will only improve their level of performance. Relaxed breathing decreases “vibrations” caused by tension.

## 5.5 TRIGGER CONTROL

### 5.5.1 General

Good trigger control is the second last technical step in carrying out a perfect shot. Consistent squeezing of the trigger assures the desired trajectory upon the departure of the pellet. When incorporated with a proper breathing sequence, trigger control becomes instinctive.

Trigger control is the manipulation of the trigger in such a way that there is no disturbance or motion of the foresight. It must be constant, controlled, slow and deliberate.

### 5.5.2 Controlling Trigger Pressure

The following criteria should be followed when correctly pulling the trigger:

- a. **Position of the Hand on the Rifle.** Cadets should have a relatively firm grip on the small of the butt with the bottom three (3) fingers of their hand. They should not

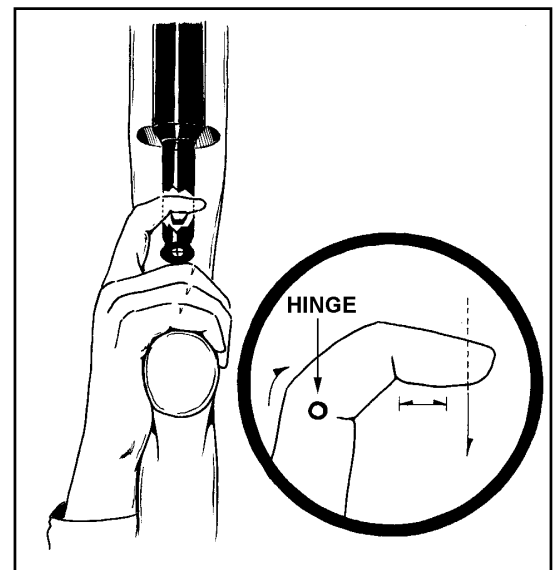

strain their hand and they should make sure the pressure they apply is consistent for every shot. The thumb should point forward and rest in a relaxed position behind the rear sight along the rifle stock or should be wrapped around the small of the butt.

- b. **Trigger Finger Position.** The index finger should be placed on the trigger halfway between the tip of the finger and the first joint. The index finger never touches the stock of the rifle and must be vertically centered on the trigger.

#### **NOTE**

Cadets should remember to always squeeze the trigger.

- c. **Squeezing the Trigger.** Trigger pressure should only be applied when the cadet is ready to fire. It must be applied straight to the rear by bending the second joint of the index finger. Cadets should make sure the pressure they apply is constant and that they slowly squeeze the trigger while they are holding their breath. The trigger of the Daisy 853C has one stage and its weight is not adjustable.

### **5.5.3 Trigger Control Exercises**

An effective trigger control exercise is to simulate the movement by using a clothespin. The clothespin should be split in two. It should be placed on the first joint of the trigger finger and the end of the thumb. Cadets should practice squeezing the clothespin slowly using only one muscle: the one in the index finger. They should then analyze the sensations felt in their hand until they can repeat this sequence when actually firing. None of the other fingers of their hand should move when doing this exercise. This exercise is most effective when done with the eyes open followed by doing it with the eyes closed, so that cadets can concentrate and feel the movement of their trigger finger.

Trigger control can also be mastered by performing dry firing exercises. This technique will be described in details in paragraph 5.9.

## **5.6 FOLLOW-THROUGH**

### **5.6.1 General**

Follow-through is essential to firing perfect shots. It is defined as the act of remaining in position for a few seconds after the pellet's departure and it requires both physical and mental effort. It aids in developing proper hold of the rifle, maintaining stability, ensuring that there is no movement of the rifle as the shot is being fired, and calling the shot after it is fired.

Follow-through is critical with air rifle marksmanship because the slower shot velocity cause the pellet to remain in the barrel for a fraction of a second longer than smallbore or largebore rifles.

If the position is stable, the aiming picture should return to the same place it was before the vibrations caused by the release of compressed air. If this sight picture differs from the initial sight picture, some improvements to the cadet's position need to be done.

## **5.7 LOADING, FIRING AND UNLOADING**

### **5.7.1 Pumping the Air Rifle**

The following guidelines should be adhered to when pumping the air rifle:

- a. Do not pump the rifle more than once per shot. This air rifle is designed to withstand the pressure based on a single pump stroke;

- b. If the air rifle is pumped more than once, or left with a full chamber pressure for an extended period (i.e., one hour), the compressed air may not expel completely upon firing. Consequently, the air rifle may have sufficient pressure remaining in the air pressure chamber to fire another pellet. Therefore, a proper unload drill must be done each time a session of firing is completed; and
- c. The cadet must pump the rifle before loading a pellet.

### **5.7.2 Loading the Air Rifle**

The following steps should be followed when loading the rifle:

- a. Pick up and hold the rifle with the left hand;
- b. Ensure the safety catch is in the ON position;
- c. Place the sling on the rifle;
- d. Pump the rifle. This method can be done effectively in two (2) different ways as outlined in paragraph 5.7.5;
- e. When the pump handle is fully extended, pause for about three (3) seconds (this is very important; if done incorrectly, the rifle will have insufficient air pressure);
- f. Bring the pump lever back to the closed position (watch the fingers!);
- g. Load a pellet or a five (5) pellet clip; and
- h. Close the bolt.

### **5.7.3 Firing the Air Rifle**

The following actions should be performed in order to fire the rifle:

- a. When the RSO gives the command, place the safety catch in the OFF position;
- b. Aim the rifle at the target;
- c. Squeeze the trigger;
- d. Open the bolt, pump the rifle, re-load, aim and fire;
- e. Repeat the last step until the firing is completed;
- f. Upon completion, place the safety catch in the ON position, open the bolt and partially open the pump lever; and
- g. Lay the rifle down.

### **5.7.4 Unloading the Air Rifle**

These steps should be followed when unloading the rifle:

- a. Pick up the rifle;
- b. Remove the five (5) pellet clip (if used);

- c. Pump the rifle (hold for three (3) seconds and close);
- d. Move the bolt forward (do not insert a pellet);
- e. Place the safety catch in the OFF position;
- f. Aim the rifle at the target;
- g. Squeeze the trigger;
- h. Open the bolt;
- i. Place the safety catch in the ON position;
- j. Open the pump lever slightly;
- k. Wait to be cleared by the RSO; and
- l. Lay the rifle down.

### 5.7.5 Pumping the Rifle

There are two (2) effective ways of pumping the rifle. The first and preferred one can be done by the cadet while the second one requires assistance from a coach. Even though the individual method may seem quite awkward, it can be easily performed by any cadet.

To pump the rifle, the cadet should follow these steps:

- a. Remove the butt from the shoulder and rest it on the mat;
- b. Partially open the pump lever with the right hand;
- c. Return the right hand to the small of the butt;
- d. Grasp the pump lever with the left hand, halfway up the lever;
- e. Lift the rifle upwards until the pump lever is fully extended (keep the left elbow on the mat);
- f. Pause for three (3) seconds when the pump lever is fully extended;
- g. Bring the rifle down, thereby returning the pump lever to the closed position;
- h. Load the pellet or the five (5) pellet clip; and
- i. Move the bolt forward.





## 5.8 IMMEDIATE ACTION AND STOPPAGES

When a problem occurs, the cadet must point the rifle down range at all times and notify the RSO. When a problem arises and the barrel needs to be cleared with a safety rod, coaches and RSOs must use extreme caution. They should be careful not to damage the bolt tip or scratch the crown of the barrel by pushing the safety rod through too hard as this could negatively affect the accuracy of the rifle. All pellets that have been cleared with a safety rod should be disposed of.

PROBLEM	SOLUTION
Pellet incorrectly seated in chamber	Place the safety catch in the ON position. Open the bolt fully to the rear. RSO will insert a safety rod in the barrel to clear the pellet.
Pellet stuck in barrel	Place the safety catch in the ON position. Open the bolt fully to the rear. RSO will insert a safety rod in the barrel to clear the pellet.
Two pellets lodged in the barrel or chamber	Attempt twice to fire the pellets out. If unsuccessful: <ol style="list-style-type: none"> <li>Place the safety catch in the ON position;</li> <li>Open the bolt fully to the rear; and</li> <li>RSO will insert a safety rod in the barrel to clear the pellet.</li> </ol>
Rifle does not fire	Conduct a functioning test: <ol style="list-style-type: none"> <li>Place the safety catch in the ON position;</li> <li>Open the bolt fully to the rear;</li> <li>Close the bolt;</li> <li>Place the safety catch in the OFF position; and</li> <li>Squeeze the trigger.</li> </ol> If the rifle still does not fire, conduct a pumping functioning test: <ol style="list-style-type: none"> <li>Place the safety catch in the ON position;</li> <li>Open the bolt fully to the rear;</li> <li>Pump the rifle;</li> <li>Close the bolt;</li> <li>Place the safety catch in the OFF position; and</li> <li>Squeeze the trigger.</li> </ol> If the rifle still does not fire, clear the rifle: <ol style="list-style-type: none"> <li>Place the safety catch in the ON position;</li> <li>Open the bolt fully to the rear and partially open the pump lever; and</li> <li>RSO will insert a safety rod in the barrel to clear the pellet.</li> </ol>
Air escapes from the pump	Replace the o-rings and lubricate the foam wiper ring.
Aperture size is incorrect	There are three (3) aperture sizes and only two (2) concern this type of usage. Use the larger or smaller of the two.
Bolt sticks (malfunction)	Check that the bolt lever is in its proper place. Ensure that there are no pellets stuck in the barrel or chamber.
Butt plate screws are too short	Replace screws with longer ones (#6-32).
Front sight is unstable	Tighten or replace the barrel weight.
Pump friction	Place <b>one</b> (1) drop of oil on the lubricating sponge of the pump.
Rear sight is unstable	Tighten the rear sight screws. Be careful not to strip the screws by over tightening.
Rear sight micrometer will not turn	Replace the sight.
Stock is broken	Replace the stock.

## 5.9 DRY FIRING

There are two (2) methods of dry firing with the Daisy 853C. The first is performed exactly the same way as live firing, except pellets are not used. This method allows the cadet to rehearse all the steps required in operating the rifle.

The second method does not require the rifle to be pumped, but only the action to be cocked. The emphasis here is on position, sight picture and trigger control.

## 5.10 USE OF THE SLING

The sling helps to support most of the weight of the rifle, ensuring minimal muscular effort on the part of the cadet.

### 5.10.1 Assembling the Sling

It is essential that the sling be assembled correctly in order to maintain a comfortable and stable position while firing.

The sling is made up of two (2) sections: a short section and a long section, with two (2) metallic clasps joining the middle. Each clasp has three (3) slots. The shorter end of the sling will go around the arm while the longer end will go on the rifle via the sling swivel. The sling swivel acts as the handstop once the sling is attached to the rifle.

To assemble the sling, follow the steps listed below:

- a. Hold the sling parallel to the ground with the short section in the left hand, ensuring that the rounded tip of the top buckle is pointing left;
- b. Take the short section, loop it up through the middle slot of the metallic clasp and then back down through the front slot (nearest the rounded tip). The short section will now form a circle; and
- c. Turn the sling over and slide the sling swivel onto the long section. Ensure the sling swivel hangs downwards, as it will later attach to the rifle. Loop the long section up through the middle slot and then back down through the front slot. It is now important to take the remaining end and loop it back through the rear slot, locking the sling in place. This will ensure that the sling will not come undone or loosen during firing.

### 5.10.2 Position of the Sling on the Arm

The sling should be positioned on the upper left arm above the biceps near the shoulder. This is the area on the arm where the smallest amount of pulse can be felt. It is held in place either by the rubber pad on the marksmanship jacket or by a strap or hook attached to the jacket. When not wearing a marksmanship jacket, a safety pin can be used to affix the sling to a sweater. The sling should never be twisted. In summary, the sling provides maximum support of the rifle with the least amount of physical effort on the part of the individual.

### 5.10.3 Adjustment of the Sling Swivel

The sling is attached to the sling swivel which lies on the pump handle. The position of the sling swivel is adjustable using a flat-blade screwdriver. It acts as a rest for the cadet's hand and its placement should be adjusted accordingly.

To determine the position of the sling swivel, the following steps are recommended:

- a. Loosen the sling swivel and slide it to the end of the rail;
- b. Have the cadet adopt the prone position **without using the sling**;

- c. Have the cadet aim the rifle down range while placing it securely in the shoulder (ensure the forearm is at least 30° from the ground); and
- d. The point on the fore-end of the stock where the cadet is gripping the stock should be the appropriate sling swivel position. Move the sling swivel to the hand position and tighten it in place using a flat-blade screwdriver.

This gives the cadet a good starting point. If any butt spacers are added on the rifle, the position of the sling swivel should be readjusted.

#### **5.10.4 Adopting the Prone Position Using a Sling**

Steps to adopting the prone position:

- a. Place the sling on the left arm;
- b. Lie down to the left of the rifle;
- c. Attach the sling hook to the sling swivel;
- d. Place the left elbow on the ground;
- e. Pick up the rifle and adjust the sling accordingly;
- f. Get into a comfortable position;
- g. Place the butt plate in the shoulder;
- h. Place the right hand in the small of butt;
- i. Let the right elbow fall to a natural position on the ground;
- j. Place the right cheek on top of the butt; and
- k. Adjust the butt plate length as appropriate.

#### **5.10.5 Attachment of the Sling to the Rifle**

The sling should already be on the cadet's arm for this step. The sling should be attached to the rifle using its hook. To attach the sling, the hook on the sling should be opened by pressing on its side screw. The hook pin should be slipped into the attachment clamp on the rifle's sling swivel and the hook should be screwed over the pin to ensure it will not fall out.

#### **5.10.6 Adjustment of the Sling**

If the sling is too loose it will no longer act as a method of support and the cadet will hold the rifle using their muscles. If the sling is too tight, blood flow will be restricted and cause a more pronounced pulse, which will have a negative effect on the cadet's hold. Therefore, the sling must be comfortable on the arm, providing maximum support, while not clinching the arm.



## SECTION 6

### MARKSMANSHIP TECHNIQUES – STANDING POSITION

This section deals with all the marksmanship skills required for proper firing in the standing position. They can be divided into five principles as follows:

- a. Position;
- b. Holding;
- c. Breathing;
- d. Aiming; and
- e. Trigger control.

These principles must all function in harmony. Improving one while not working on another will not provide very good results in the long run. Perfecting these principles takes time and concentration, cadets should remember – **PRACTICE MAKES PERFECT!**

#### 6.1 THE STANDING POSITION

##### 6.1.1 General

The standing position is the easiest and quickest position to assume and does not require any artificial support like the sling in the prone position. It has the smallest area of support, thus it is the most difficult to hold steady. Cadets must come to grips with the fact that when firing in the standing position, they may never achieve complete immobility.

Obtaining a good position is one of the most, if not the most important principle of marksmanship, especially when firing in the standing position. A good position helps to maintain balance, comfort and stability during the firing session. Although an excellent position will not guarantee an excellent performance, a poor position can almost assure a substantially negative effect on results.

##### 6.1.2 Rifle Rests

An excellent way to practice marksmanship skills required by a cadet is to use a rifle rest such as an adjustable camera stand. This allows the cadet to perfect and to understand their marksmanship skills while the rifle is held steady. Once these skills are learned, the rifle rest should be removed. This technique proves to be very helpful in the standing position since the oscillations of the rifle are amplified due to the lack of support points of the position.

##### 6.1.3 Obtaining a Good Position

The objective of a good position is to obtain a stable, balanced, uniform platform in the most efficient way possible allowing holding and aiming to be achieved with as little movement and muscular tension as possible.

The standing position should be:

- a. Natural;
- b. Without strain;
- c. Comfortable;
- d. Stable;

- e. Balanced in such a way that body weight is equally distributed; and
- f. Consistent throughout the relay.

### 6.1.4 Centre of Gravity

The centre of gravity is the point where the weight of the rifle and the cadet's body weight are evenly distributed between the feet. In order to compensate for the weight of the rifle, the cadet's back is bent rearward and rotated to the left in order to gain bone support and stability.

If the cadet stands straight, the weight of the rifle will pull their body to the front. Muscle strain will appear in the back as the cadet attempts to keep their body from falling forward. By bending backward and rotating the back to the left, a shift in body weight will occur slightly towards the right foot. At a certain point, the weight of the body on the right foot will equal the weight on the left foot. The body-rifle combination then reaches a state of balance, with the centre of gravity located between the cadet's two (2) feet.

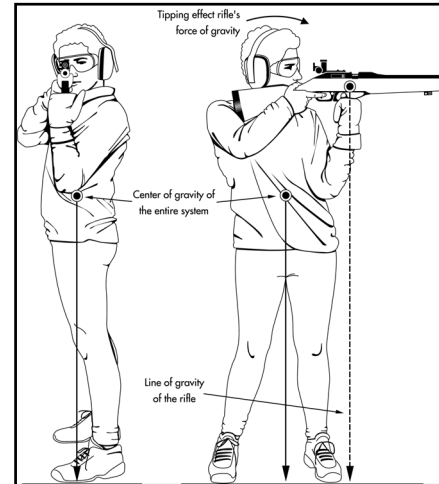

### 6.1.5 Characteristics of a Good Position

The following guidelines should be adhered to when adopting the standing position:

- a. The body should face to the right, approximately 90° to the target;
- b. The feet should be shoulder width apart and cadets should try to stand on the firmest surface possible. They should use comfortable flat sole shoes or boots to add stability to their position;
- c. The weight of the body and the rifle should be equally distributed between the feet;
- d. The feet should point straight ahead in relation to the body or could be turned slightly outward for comfort;
- e. The legs should be straight but not locked as locked knees will affect blood circulation, eventually causing increased discomfort and unsteadiness;
- f. The hips should be 90° to the target and should not thrust forward;
- g. A proper centre of gravity between the body and the rifle should be established. This can be achieved through the use of back bend and body twist. To do this:
  - (1) place the rifle in the shoulder, bend slightly backwards at the waist, ensuring the legs remain straight; and

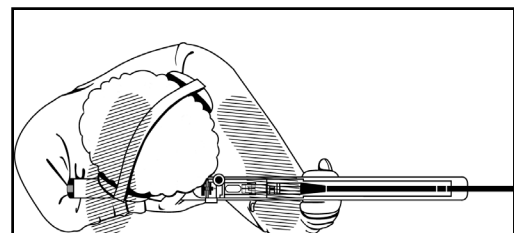

- (2) twist the torso from the small of the back (do not rotate the hips);

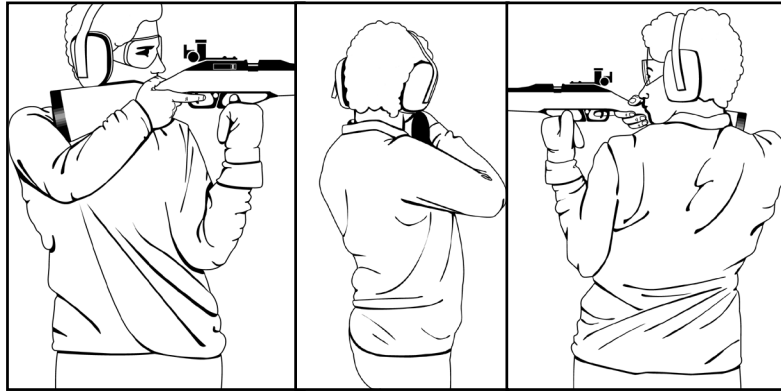

**NOTES**

1. A correctly executed back bend and body twist will result in the weight of the rifle-body mass being supported by the bones of the lower spinal column. Therefore, the standing position utilizes the bones of the body to support the weight of the rifle, not the muscles.
  2. The combination of back bend and body twist is the most important feature of the standing position and will contribute significantly to the cadet's level of performance. However, cadets should understand that discomfort is common during the first few practice sessions. After a short period of time, however, this discomfort will diminish and an increasingly stable hold will be achieved.
- h. The left arm should rest against the rib cage. The left elbow should almost be directly under the rifle. Muscles should not be used to support the left arm. Like the body, the left arm should be placed in a point of balance. The muscles in the left arm must not be used to correct sight alignment;
- i. The left hand is used to support the rifle and should be positioned just forward of the trigger guard. There are several ways of holding the rifle, such as:

- (1) using a clenched fist;



- (2) forming a "V" shape with the thumb and fingers;



- (3) using the “split fingers” technique; and



- (4) using the heel of the hand while keeping the fingers relaxed;

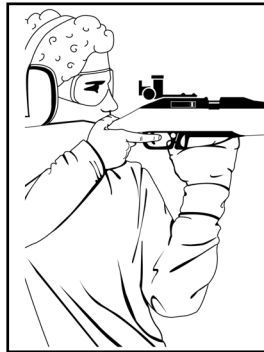

- j. The right hand should be comfortable and under no strain. The right arm should drop naturally to the side. The trigger finger should not touch the stock. The position should allow the right hand, when placed on the pistol grip, to produce a straight back trigger pull;
- k. The head should be in an upright position with the eyes looking forward through the rear sight. To prevent involuntary body sway as a result of the balance mechanism in the inner ear, the head should remain straight and upright. The stock should rest high in the shoulder pocket bringing the sights up to eye level to keep from tipping the head forward to aim. In order to keep the head erect, it may be necessary to slightly cant the rifle to the left. If a cant is required, it is important for the cant to remain the same for every shot;
- l. The head should rest on the cheek piece of the rifle and should not be held up by the neck muscles; and
- m. Eye relief distance should be between 5-15 cm and should usually be slightly greater than in the prone position.

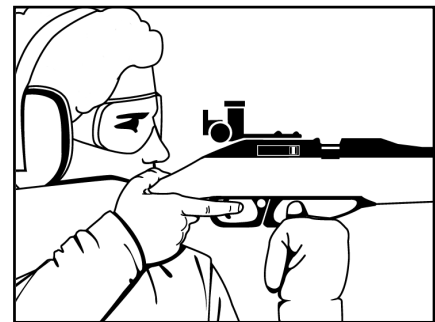

To ensure positive results, the aforementioned points should be repeated for each shot. The feet must always be in the same place, the backbend and body twist must always be consistent, the left elbow must always be in the same place on the rib cage, and the left hand position must always be the same. Also, the head must be levelled and exert the same amount of pressure on the cheek piece, the eye relief must remain constant and the right hand must always be in the same position. If any of these points does not feel right or if the cadet finds the position uncomfortable, their position should be readjusted until it is better.



### 6.1.6 Adopting the Standing Position

Cadets should begin by firing on a rest. After they can attain a tight group, the rest should be removed and cadets should fire on their own. The following steps should be adhered to when adopting the standing position using a rifle rest:

- a. Lay the rifle down on a table;
- b. Stand 90° to the target;
- c. Position the feet shoulder width apart;
- d. Pick up the rifle;
- e. Place the butt plate high in the shoulder pocket;
- f. Position the left hand under the rifle stock;
- g. Lay the right hand on the small of the butt;
- h. Orient the position towards the target;
- i. Lay the rifle on the rest;
- j. Adjust the height of the rest; and
- k. Adjust the length of the butt using spacers.

When not using a rest, the same steps mentioned above should be followed except for point j.

## 6.2 AIMING

### 6.2.1 Front Sight

The front aperture should be selected to provide the best sight picture. A good sized aperture should appear 1-1/2 times bigger than the aiming mark. When firing in the standing position, the larger of the two (2) circular apertures should be used to allow the cadet to better see the aiming mark that will be shifting around more than in the prone position.

### 6.2.2 Rear Sight

#### a. Elevation

To lower the point of impact, turn the elevation knob counterclockwise (to the left). To raise the point of impact, turn the elevation knob clockwise (to the right), as per the arrow and the word "UP".

However, if the rifle is canted to allow the cadet to keep their head leveled, an adjustment for height will move the point of impact in a diagonal line equal to the angle of the rifle's cant. Therefore, when an adjustment for height is made, a lateral adjustment must be made to ensure the point of impact moves in a perfectly vertical manner. For example, when adjusting the sight downward by nine (9) clicks, an additional three (3) clicks to the left may be required to compensate for the cant of the rifle.



**b. Windage**

To move the point of impact to the left, turn the windage knob counterclockwise (to the left). To move the point of impact to the right, turn the windage knob clockwise (to the right), as per the arrow and the letter "R".

Again, as for adjustments in elevation, compensation must be taken into account for the cant of the rifle. For example, when adjusting the sight to the right by six (6) clicks, an additional two (2) clicks downward may be required to compensate for the cant of the rifle.

**Remember: Sight Adjustment**

**UP & RIGHT = clockwise**  
**DOWN & LEFT = counterclockwise**

**If the rifle is canted, sights will also need to be adjusted laterally when being adjusted for height**

**6.2.3 Proper Head Position**

The head should be kept as close as possible to a position which allows the eyes to look straight forward from the eye socket. To illustrate the penalty for not doing this, cadets should try moving their eyes as far in one direction as they can (up, down, right or left) in the eye socket. Instantly they will feel a strain on their eyes. The more their eyes are looking straight forward from the eye socket, the more relaxed their eye muscles will be.

**6.2.4 Eye Relief**

Eye relief is the distance between the eye and the rear sight. Depending on an individual's build and position, this distance is usually 5 to 15 cm. This distance may have to be reduced slightly due to the size of the Daisy 853C rifle. Cadets should strive to achieve an eye relief that is comfortable, natural, and allows them to see a circle of light around the front sight as they look through the rear sight. It is important for them to maintain the same eye relief from shot to shot and to find an eye relief that allows them to keep their head as erect as possible during the firing process. If they get closer than 5 cm from the sight, the line of white around the front sight becomes larger and more difficult to keep aligned.

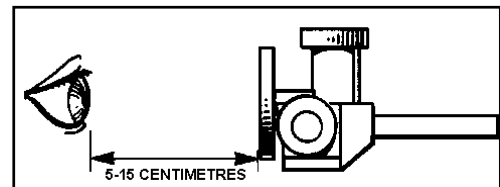

**6.2.5 Sight Alignment**

Sight alignment is the most critical element of the aiming process. It is the alignment of the eye, the rear sight, and the front sight.

When cadets bring their eye 5 to 15 cm from the rear sight, they will find that the small hole is large enough to look through and see all of the front sight. This is what they see when they have achieved proper sight alignment.

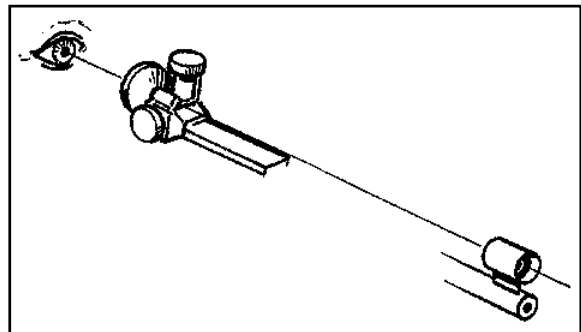

### 6.2.6 Sight Picture

To obtain a proper sight picture, a bullseye is simply added to the innermost ring. The goal during the aiming process is to maintain proper sight alignment while keeping the bull centered in the front sight.

The ultimate goal is to have all the circles in perfect alignment, but even Olympians can only reach this perfection and hold it for no more than a few seconds at a time when firing in the standing position.

Cadets must constantly strive to maintain proper sight alignment, while obtaining a sight picture. It is the most critical element of the aiming process.

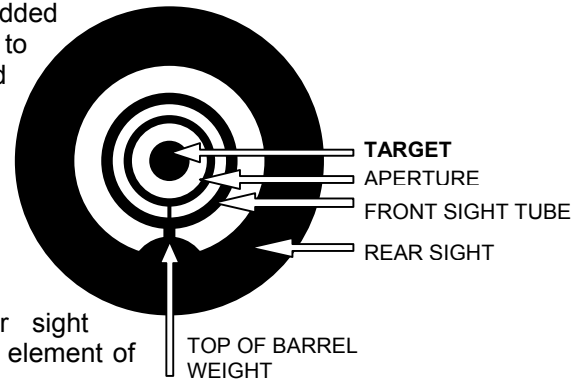

### 6.2.7 Natural Alignment

Natural alignment is obtained when the rifle can be perfectly aimed at the target without being muscled into achieving this. In a comfortable position, the cadet does not force the air rifle to point to the target, which would create muscular tension. Proper alignment will also prevent “drifting” of the group during a course of fire.

After establishing a comfortable position, the cadet must now make sure that their body and rifle are directly aligned with the target. In order to understand the notion of natural alignment it is important to remember that the rifle is supported by the bones and not the muscles.

In order to ensure that the position is directly in line with the target, cadets should follow these steps:

- a. Assume a proper standing position, look through the sights and acquire a proper sight picture;
- b. Close their eyes, take several normal breaths and relax into a comfortable position;
- c. Once comfortable, look through the sights again. If perfectly centered with the target, proceed with firing;
- d. If not directly centered with the target, re-orient the position slightly. To do this, modify the alignment in the following manner:
  - (1) to aim higher, move the left hand position rearward or widen the stance slightly;
  - (2) to aim lower, move the left hand position forward or reduce the size of the stance; and
  - (3) to aim to the left or right, move the feet forwards or backwards in relation to the line of sight; and
- e. Close their eyes and do a final check on their alignment. If not perfectly aligned, they must start over!

Again, it is essential that cadets use their bones to support the rifle, so that their muscles remain relaxed. Under no circumstances should they use their muscles to change the point of aim by moving the rifle from side to side. If they do a proper follow-through, the rifle will automatically return to the point of aim if they are not using muscular force.

It is also important that cadets check their alignment during their course of fire to ensure their position has not shifted. Note also that “warmed” muscle groups react differently from “cold” muscle groups. It is important to allow for a proper warm-up prior to firing. A brief warm-up exercise is described in Section 13.

### 6.2.8 Aiming Process

After establishing their natural alignment, cadets are now ready to move along to the actual sequence of aiming. The aiming process is as follows:

- a. Adopt a comfortable position;
- b. Make sure the alignment with the target is adequate;
- c. Verify the size of the front aperture; and
- d. Follow the procedures described in paragraphs 5.3.5 and 5.3.6.

During the first attempts to fire in the standing position, the rifle will move a great deal. This is normal for a beginner. However, it is important for the cadet to accept these hold movements as normal and to fire the shot without trying to make it absolutely perfect. The diagram below clearly pictures the differences in holding between the prone and standing positions.

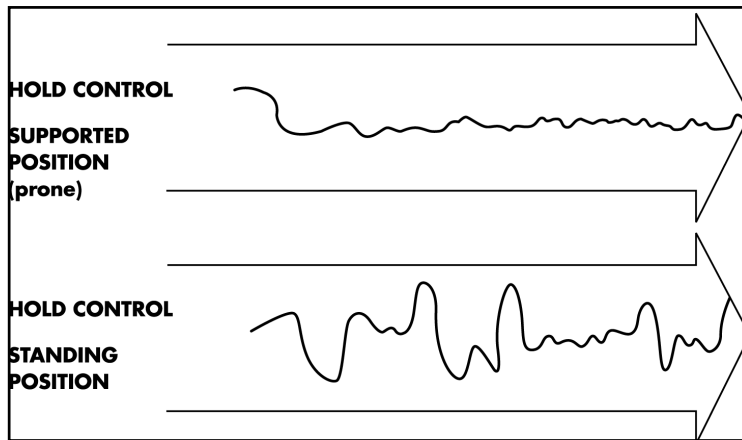

## 6.3 BREATHING

### 6.3.1 Importance of Breathing

Once a stable position is established, cadets must integrate the principles of breathing. While breathing, the oxygen inhaled is used to supply muscles with energy, ensuring optimal potential of these muscles. This includes the muscles that are involved in the position, as well as the muscles in the eyes.

For maximum stability when firing, cadets will have to stop breathing for a few seconds. It is of the utmost importance that they do not hold their breath for more than five (5) to seven (7) seconds, as the tension will increase in their chest muscles and reduce stability. This is of the utmost importance in the standing position as the decrease in stability will be greatly amplified by the lack of contact points with the ground.

### 6.3.2 The Breathing Cycle

In order to achieve a proper breathing sequence, the information in the following graph should be adhered to:

## BREATHING CYCLE

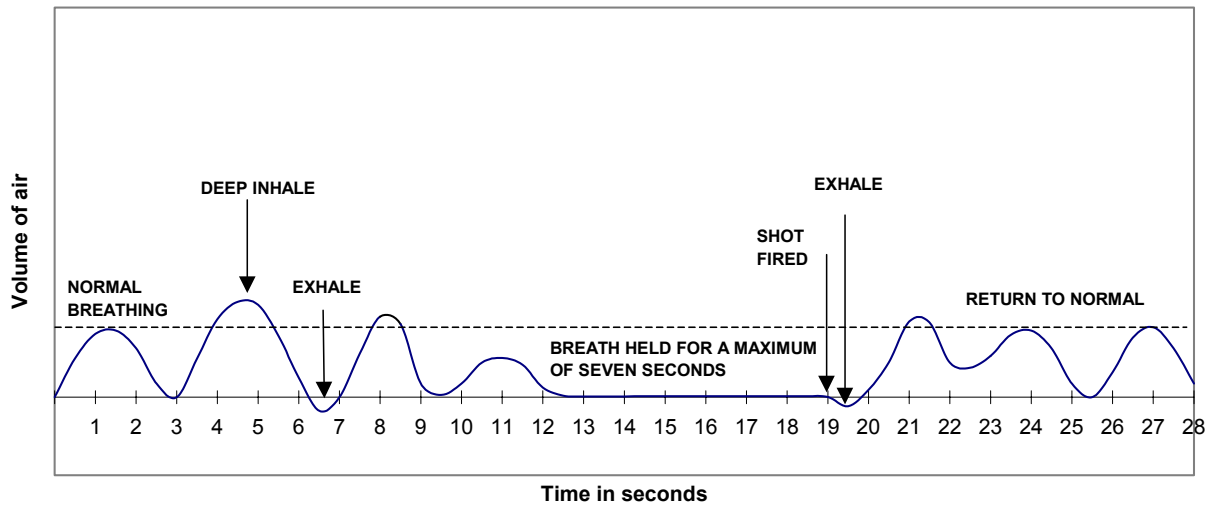

Breathing should be relaxed and normal as cadets establish a sight picture. Then, they should inhale and exhale deeply, take another deep inhale, exhale normally, and completely release their chest muscles and hold their breath. After the shot, a small exhale is followed by normal breathing, and the cycle is repeated.

### 6.4 TRIGGER CONTROL

#### 6.4.1 Controlling Trigger Pressure

The following criteria should be followed when pulling the trigger:

- Position of the Hand on the Rifle.** Cadets should have a relatively firm grip on the small of the butt with the bottom three (3) fingers of their hand. They should not strain their hand and they should make sure the pressure they apply is consistent for every shot. The thumb should point forward and rest in a relaxed position behind the rear sight along the rifle stock or should be wrapped around the small of the butt.
- Trigger Finger Position.** The index finger should be placed on the trigger halfway between the tip of the finger and the first joint. The index finger never touches the stock of the rifle and must be vertically centered on the trigger.
- Squeezing the Trigger**

Trigger pressure should only be applied when the cadet is ready to fire. It must be applied straight to the rear by bending the second joint of the index finger. Cadets should make sure the pressure they apply is constant and that they slowly squeeze the trigger while they are holding their breath. The trigger of the Daisy 853C has one stage and its weight is not adjustable.

Due to the fairly heavy trigger weight of the Daisy 853C and the lesser degree of stability of the standing position, cadets should be slightly more aggressive squeezing the trigger than in the prone position. This means that cadets should still squeeze the trigger gradually, however, doing it in a more rapid fashion since the perfect sight picture will not remain there as long as when firing prone.

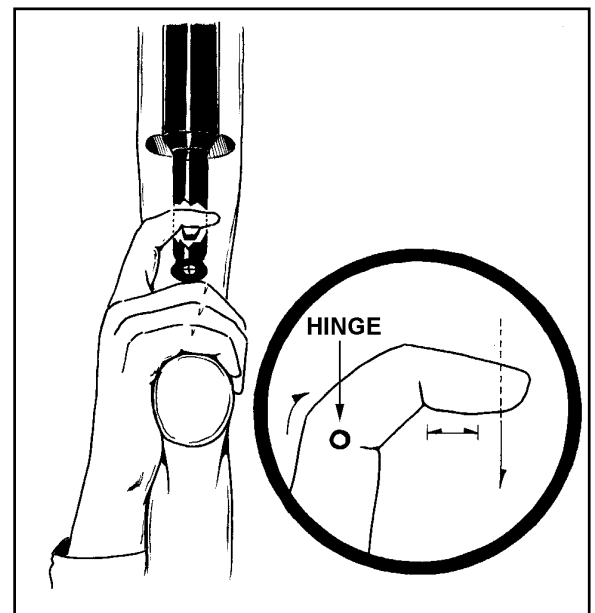

#### NOTE

Cadets should remember to always squeeze the trigger.

## **6.5 FOLLOW-THROUGH**

### **6.5.1 General**

Follow-through is essential to firing perfect shots. It is defined as the act of remaining in position for a few seconds after the pellet's departure and it requires both physical and mental effort. It aids in developing proper hold of the rifle, maintaining stability, ensuring that there is no movement of the rifle as the shot is being fired, and calling the shot after it is fired.

If the position is stable, the aiming picture should return to the same place it was before the vibrations caused by the release of compressed air. If this sight picture differs from the initial sight picture, some improvements to the cadet's position need to be done.

## **6.6 LOADING, FIRING AND UNLOADING**

### **6.6.1 Pumping the Air Rifle**

The following guidelines should be adhered to when pumping the air rifle:

- a. Do not pump the rifle more than once per shot. This air rifle is designed to withstand the pressure based on a single pump stroke;
- b. If the air rifle is pumped more than once, or left with a full chamber pressure for an extended period (i.e., one hour), the compressed air may not expel completely upon firing. Consequently, the air rifle may have sufficient pressure remaining in the air pressure chamber to fire another pellet. Therefore, a proper unload drill must be done each time a session of firing is completed; and
- c. The cadet must pump the rifle before loading a pellet.

### **6.6.2 Loading the Air Rifle**

The following steps should be followed when loading the rifle (the rifle should always point towards the targets):

- a. Pick up and hold the rifle with the left hand;
- b. Ensure the safety catch is in the ON position;
- c. Pump the rifle. This can be done effectively in three (3) different ways as described in paragraph 6.6.5;
- d. When the pump handle is fully extended, pause for about three (3) seconds (this is very important; if done incorrectly, the rifle will have insufficient air pressure);
- e. Bring the pump lever back to the closed position (watch the fingers!);
- f. Load a pellet or a five (5) pellet clip; and
- g. Close the bolt.

### 6.6.3 Firing the Air Rifle

The following actions should be performed in order to fire the rifle (the rifle should always point at the targets):

- a. When the RSO gives the command, place the safety catch in the OFF position;
- b. Aim the rifle at the target;
- c. Squeeze the trigger;
- d. Open the bolt, pump the rifle, re-load, aim and fire;
- e. Repeat the last step until the firing is completed;
- f. Upon completion of the firing, place the safety catch in the ON position, open the bolt and partially open the pump lever; and
- g. Lay the rifle down.

### 6.6.4 Unloading the Air Rifle

These steps should be followed when unloading the rifle (the rifle should always point at the targets):

- a. Pick up the rifle;
- b. Remove the five (5) pellet clip (if used);
- c. Pump the rifle (hold for three (3) seconds and close);
- d. Move the bolt forward (do not insert a pellet);
- e. Place the safety catch in the OFF position;
- f. Aim the rifle at the target;
- g. Squeeze the trigger;
- h. Open the bolt;
- i. Place the safety catch in the ON position;
- j. Open the pump lever slightly;
- k. Wait to be cleared by the RSO; and
- l. Lay the rifle down.

### 6.6.5 Pumping the Air Rifle

To pump the rifle, the cadet should follow these steps:

- a. With the rifle resting on a table, pick up and hold the rifle with the left hand;
- b. Establish a good standing position close enough to the table to allow access to the rifle and equipment placed on the table;

- c. Pump the rifle. This method can be done in three (3) different ways:

**Option 1.** Grasp the pistol grip with the right hand. Grasp the pump handle with the left hand. Push downward with the left hand until the pump handle is fully extended. Wait for a few seconds. Using the left hand, bring the pump handle back to the stock of the rifle. The rifle should remain stationary during the pumping process and always point towards the targets.

**Option 2.** Grasp the pistol grip with the right hand. Grasp the pump handle with the left hand. Place the butt of the rifle under the right arm or shoulder for support. Push downward with the left hand until the pump handle is fully extended. Wait for a few seconds. Using the left hand, bring the pump handle back to the stock of the rifle allowing the underarm and shoulder to help hold the rifle steady when closing the pump handle. Remember that the rifle must always point towards the targets.

**Option 3.** Coach assistance. Point the rifle in a safe direction and request the assistance from a coach. The coach should move in and pump the rifle using both hands. This should be used as a last resort as any cadet can easily do the above two (2) options;

- d. Load the pellet or five (5) pellet clip; and
- e. Move the bolt forward.



## SECTION 7

### MARKSMANSHIP TECHNIQUES – KNEELING POSITION

This section deals with all the marksmanship skills required for firing in the kneeling position. They can be divided into five principles as follows:

- a. Position;
- b. Holding;
- c. Breathing;
- d. Aiming; and
- e. Trigger control.

These principles must all function in harmony. Improving one of the five principles of marksmanship, while not working on another, will not provide very good results in the long run. Perfecting these principles takes time and concentration, cadets should remember – **PRACTICE MAKES PERFECT!**

#### 7.1 THE KNEELING POSITION

##### 7.1.1 General

The kneeling position is a very stable position similar to the prone position, except achieving a comfortable position which is stable and minimizes movement is more difficult to achieve. The kneeling position is characterized by most firers as the least comfortable position and the most difficult to adopt correctly. Slight changes in the position can result in substantial instability, poor performance, and discomfort. Obtaining a good kneeling position takes practice and flexibility, and some discomfort may be experienced by cadets.

The kneeling position uses a sling and contacts the floor at three points:

- a. The kneeling roll and foot combination;
- b. The right knee; and
- c. The left foot.

A correctly adopted kneeling position, combined with substantial practice will result in stability and results similar to the prone position.

##### 7.1.2 Rifle Rests

An excellent way to practice marksmanship skills required by a cadet is to use a rifle rest such as an adjustable camera stand. This allows the cadet to perfect and to understand their marksmanship skills while the rifle is held steady. Once these skills are learned, the rifle rest should be removed.

##### 7.1.3 Obtaining a Good Position

The objective of a good position is to obtain a stable, balanced, uniform platform in the most efficient way possible, while allowing holding and aiming to be achieved with as little movement and muscular tension as possible.



The kneeling position should be:

- a. Natural;
- b. Without strain;
- c. Comfortable;
- d. Stable;
- e. Balanced in such a way that body weight is distributed between the main support points; and
- f. Consistent throughout the relay.

#### 7.1.4 Kneeling Roll

A kneeling roll is a piece of equipment that many firers find improve the stability and comfort of the kneeling position. The main function of the kneeling roll is to provide support under the right foot which the cadet sits upon. The kneeling roll is not always required especially with very flexible shooters. It is recommended cadets attempt the kneeling position using both a kneeling roll and then not using the kneeling roll to determine which method best suits the cadet's body type.



The kneeling roll can be made from various materials like canvas, cotton, or other flexible materials and filled with material which will allow for the roll to form to the cadet's foot. Materials that may be used to fill the kneeling roll are dry beans, small plastic beads, wood chips, or other similar materials. The design of the kneeling roll should allow material to be added or removed as required.

#### 7.1.5 Characteristics of a Good Position

The following guidelines should be adhered to when adopting the kneeling position:

- a. The body should face 30° to 60° to the target, with the left leg pointed in the direction of the target;
- b. The kneeling roll should be placed at the same angle to the target as the right leg. The kneeling roll should be form fitted to the cadet's foot during the preparation stage and before attempting to fine tune the position;
- c. The left foot and kneeling roll will form a straight line to the target;
- d. The right knee is placed on the floor at 30° to 60° to the body with the right foot sitting comfortably into the kneeling roll. Approximately 20% of the body weight is supported by the right knee;

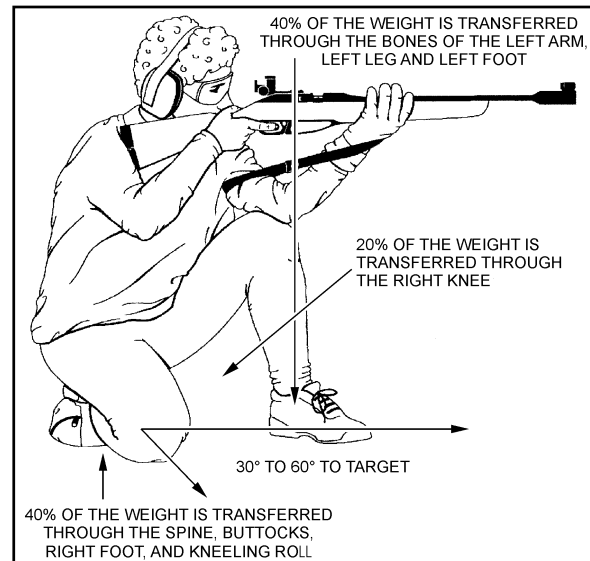

- e. The right heel sits as close to the centre of the buttocks as possible. The right shoe tip sits comfortably on the floor. This combination supports a significant portion of the cadet's weight and this weight is transferred down the spine, into the foot and finally into the kneeling roll. Approximately 40% of the body weight is supported by the kneeling roll and right foot;
- f. The sling is attached to the rifle and the left elbow sits firmly upon the left knee. The combination of the sling, left elbow and rifle form a load-bearing triangle similar to the prone position;
- g. The left hand should rest in the sling and firmly against the sling swivel. The fingers of the left hand should not grip the fore-end of the stock. The hand should be relaxed and the rifle should rest in the palm of the hand;
- h. The placement and subtle position changes of the left foot regulate the natural alignment of the position. By altering the location, angle, and position of the left foot, changes in height and right/left direction can be achieved;
- i. The rifle is placed into the right shoulder and the upper body leans against the rifle, which is held into position with the rifle sling;
- j. The left leg from the knee to the floor is at a 70° to 90° angle to the floor. The left foot is turned towards the right side of the body to improve stability of the left leg. Approximately 40% of the body weight is supported by the left leg;
- k. The shoulders should be straight and form right angles with the spine;
- l. The butt plate is kept firmly in the hollow of the right shoulder. In order to ensure that the butt plate is always placed in the same spot, cadets should grasp it with their thumb and forefinger and place it in their shoulder for each and every shot;
- m. The right arm should fall comfortably and naturally to the side of the body and the right hand should be placed upon the small of the butt. The right hand should be comfortable and under no strain. The trigger finger should not touch the stock. The position should allow the right hand, when placed on the small of the butt, to produce a straight back trigger pull;
- n. The head rests comfortably on the cheek piece and remains straight and level. There should be a minimal distance of approximately five (5) cm between the right eye and the rear sight (known as eye relief). This distance should remain constant throughout the relay. When the face is placed on the cheek piece, the cadet should be looking directly through the sights. If this is not the case, their position should be modified; and
- o. To assist with firing in the kneeling position, cadets should use a chair or adjusting device to place their pellets, and equipment. The chair or adjusting device eliminates the requirement to move the position to reach for targets, pellets or other equipment during a course of fire. The chair or adjusting device cannot provide any type of artificial support.

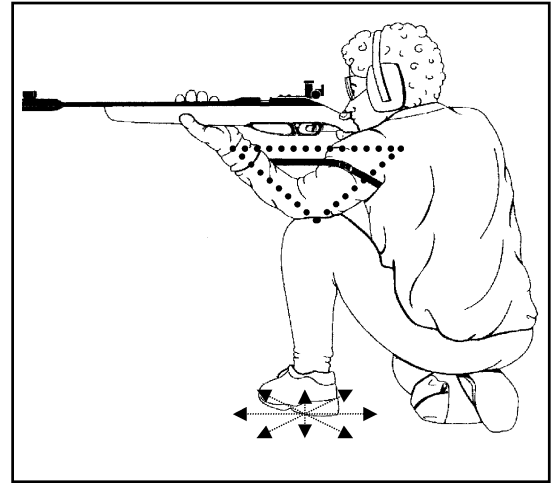

To ensure positive results, the aforementioned points should be repeated for each shot. The position and weight distribution of the left leg, right knee, right foot and kneeling roll must remain the same. The head must be levelled and exert the same amount of pressure on the cheek piece, the eye relief must remain constant and the right hand must always be in the same position. If any of these points do not feel right or if the cadet finds the position uncomfortable, the position should be adjusted until the condition is improved.

## **7.2 USE OF THE SLING**

The sling acts to support most of the weight of the rifle and some of the upper body when in the kneeling position. The sling ensures minimal muscular effort on the part of the cadet when firing.

### **7.2.1 Assembling the Sling**

It is essential that the sling be assembled correctly in order to maintain a comfortable and stable position while firing in the kneeling position.

The sling is made up of two (2) sections; a short section and a long section, with two (2) metallic clasps joining in the middle. Each clasp has three (3) slots. The shorter end of the sling will go around the arm while the longer end will go on the rifle via the sling swivel. The sling swivel acts as the handstop once the sling is attached to the rifle.

To assemble the sling, follow the steps listed below:

- a. Hold the sling parallel to the ground with the short section in the left hand, ensuring that the rounded tip of the top buckle is pointing left;
- b. Take the short section, loop it up through the middle slot of the metallic clasp and then back down through the front slot (nearest the rounded tip). The short section will now form a circle; and
- c. Turn the sling over and slide the sling swivel onto the long section. Ensure the sling swivel hangs downwards, as it will later attach to the rifle. Loop the long section up through the middle slot and then back down through the front slot. It is now important to take the remaining end and loop it back through the rear slot, locking the sling in place. This will ensure that the sling will not come undone or loosen during firing.

### **7.2.2 Position of the Sling on the Arm**

The slings should be positioned on the upper left arm above the bicep near the shoulder. This is the area on the arm where the smallest amount of pulse can be felt. It is held in place either by the rubber pad on the marksmanship jacket or by a strap or hook attached to the jacket. When not wearing a marksmanship jacket, a safety pin can be used to affix the sling to a sweater. The sling should never be twisted. In summary, the sling provides maximum support of the rifle with the least amount of physical effort on the part of the individual.

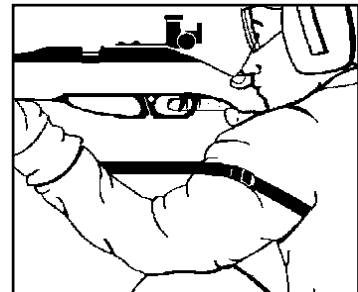

### **7.2.3 Adjustment of the Sling Swivel**

The sling is attached to the sling swivel which lies on the pump handle. The position of the sling swivel is adjustable using a flat-blade screwdriver. It acts as a rest for the cadet's hand and its placement should be adjusted accordingly.

To determine the position of the sling swivel, the following steps are recommended:

- a. Loosen the sling swivel and slide it to the end of the rail;

- b. Have the cadet adopt the kneeling position without using the sling;
- c. Have the cadet aim the rifle down range while placing it securely in the shoulder; and
- d. The point on the fore-end of the stock where the cadet is gripping the stock should be the appropriate sling swivel position. Move the sling swivel to the hand position and tighten it in place using a flat-blade screwdriver.

This gives the cadet a good starting point. If any butt spaces are added on the rifle, the position of the sling swivel should be adjusted.

#### **7.2.4 Adopting the Kneeling Position Using a Sling**

Steps to adopting the kneeling position:

- a. Place the sling on the left arm;
- b. Adopt the kneeling position to the left of the rifle as described in paragraph 7.1.5;
- c. Pickup the rifle and attach the sling hook to the sling swivel while ensuring the rifle is pointed down range;
- d. Place the left elbow upon the left knee ensuring the rifle is pointed down range. Adjust the sling accordingly;
- e. Get into a comfortable position;
- f. Place the butt plate in the shoulder;
- g. Place the right hand in the small of the butt;
- h. Let the right elbow fall to a natural position beside the body;
- i. Place the right cheek on top of the butt; and
- j. Adjust the butt plate length as appropriate.

#### **7.2.5 Attachment of the Sling to the Rifle**

The sling should already be on the cadet's arm for this step. The sling should be attached to the rifle using its hook. To attach the sling, the hook on the sling should be opened by pressing on its side screw. The hook pin should be slipped into the attachment clamp on the rifle's sling swivel and the hook should be screwed over the pin to ensure it will not fall out.

#### **7.2.6 Adjustment of the Sling**

If the sling is too loose it will no longer act as a method of support and the cadet will hold the rifle using their muscles. If the sling is too tight, blood flow will be restricted and cause a more pronounced pulse, which will have a negative effect on the cadet's hold. Therefore, the sling must be comfortable on the arm, providing maximum support, while not clinching the arm.

### 7.3 AIMING

#### 7.3.1 Front Sight

The front aperture should be selected to provide the best sight picture. A good sized aperture should appear 1-1/2 times bigger than the aiming mark. When firing in the kneeling position, most shooters find the aperture used in the prone position is used in the kneeling position.

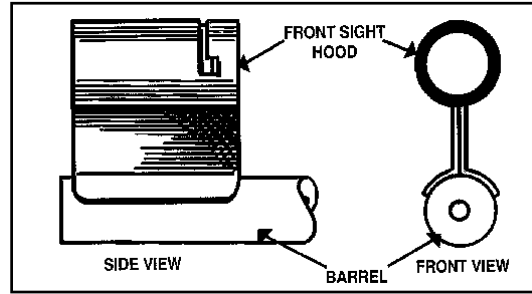

#### 7.3.2 Rear Sight

The part of the rear sight that is looked through is the peep sight. It is a small disk about the size of a penny with a small hole in the middle.

The rear sight has two (2) knobs that are used to move the point of impact of the shot. The adjustment of the knobs is measured in clicks that can be felt as the knob is turned. It takes three (3) clicks to move the point of impact approximately one pellet width. At a distance of ten (10) metres, each click equals approximately a 1.219-mm shift of the point of impact.

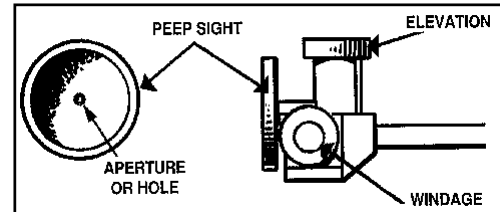

- a. **Elevation.** To lower the point of impact, turn the elevation knob counterclockwise (to the left). To raise the point of impact, turn the elevation knob clockwise (to the right), as per the arrow and the word "UP" which is written on the elevation knob.
- b. **Windage.** To move the point of impact to the left, turn the windage knob counterclockwise (to the left). To move the point of impact to the right, turn the windage knob clockwise (to the right), as per the arrow and the letter "R" which is written on the windage knob.

**Remember: Sight Adjustment**

**UP & RIGHT = clockwise**  
**DOWN & LEFT = counterclockwise**

#### 7.3.3 Proper Head Position

The head should be kept as close as possible to a position which allows the eyes to look straightforward from the eye sockets. It is acceptable for the head to tilt forward slightly, but cadets must resist allowing the head to tilt to the left or right as this affects their sense of balance.

#### 7.3.4 Eye Relief

Eye relief is the distance between the eye and the rear sight. Depending on the individual's build and position, this distance is usually 5 to 15 cm. This distance may have to be reduced slightly due to the size of the Daisy 853C air rifle. Cadets should strive to achieve an eye relief that is comfortable, natural, and allows them to see a circle of light around the front sight as they look through the rear sight. It is important for them to maintain the same eye relief from shot to shot and to find an eye relief that allows them to keep their head as erect as possible during the firing process. If they get closer than 5 cm from the sight, the line of white around the front sight becomes larger and more difficult to keep aligned.

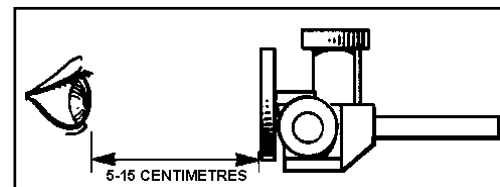

### 7.3.5 Sight Alignment

Sight alignment is the most critical element of the aiming process. Sight alignment is the alignment of the eye, the rear sight, and the front sight with the target.

When cadets bring their eye 5 to 15 cm from the rear sight, they will find that the small hole is large enough to look through and see all of the front sight. This is what they see when they have achieved proper sight alignment.

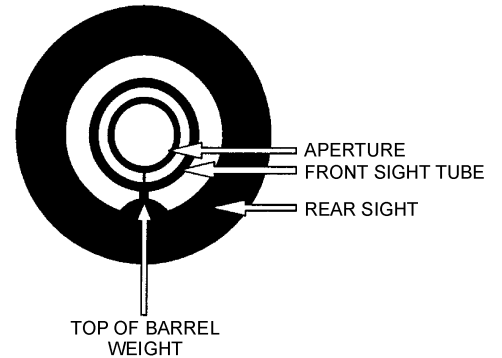
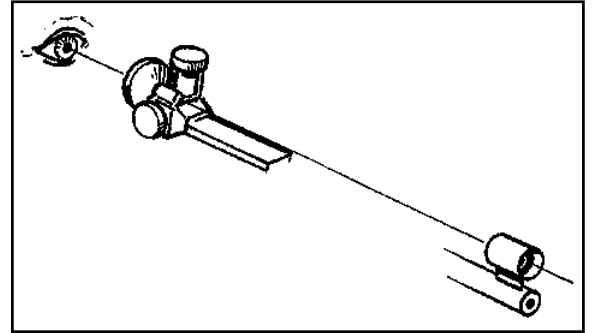

### 7.3.6 Sight Picture

To obtain a proper sight picture, simply align the target to the innermost ring. The goal during the aiming process is to maintain proper sight alignment while keeping the target centered in the front sight.

The ultimate goal is to have all the circles in perfect alignment, but even Olympians can only reach this perfection and hold it for no more than a few seconds at a time when firing.

Cadets must constantly strive to maintain proper sight alignment, while obtaining a sight picture. It is the most critical element of the aiming process.

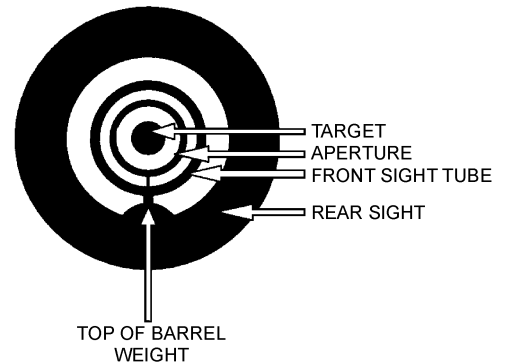

### 7.3.7 Natural Alignment

Natural alignment is obtained when the rifle can be perfectly aimed at the target without being muscled into achieving this. In a comfortable position, the cadet does not force the air rifle to point to the target, which would create muscular tension. Proper alignment will also prevent "drifting" of the group during a course of fire.

After establishing a comfortable position, the cadet must now make sure that their body and rifle are directly aligned with the target. In order to understand this notion of natural alignment it is important to remember that the rifle is supported by the bones of the body and not by the muscles.

In order to ensure that the position is directly in line with the target, cadets should follow these steps:

- a. Assume a proper kneeling position, look through the sights and acquire a proper sight picture;
- b. Close both eyes, take several normal breaths and relax into a comfortable position;

- c. Once comfortable, look through the sights again. If perfectly centered with the target, proceed with firing;
- d. If not directly centered with the target, re-orient the position; and
- e. Close their eyes and do a final check on their alignment. If not perfectly aligned, they must continue to adjust their position.

Again, it is essential that cadets use their bones to support the rifle, so that their muscles remain relaxed. Under no circumstances should they use their muscles to change the point of aim by moving the rifle from side to side. If they do a proper follow-through, the rifle will automatically return to the natural point of aim if they are not using muscular force.

It is important that cadets check their alignment during their course of fire to ensure their position has not shifted. Note also, “warmed” muscles groups react differently from “cold” muscle groups. It is important to allow for a proper warm-up prior to firing. A brief warm-up exercise is described in Section 14.

### 7.3.8 Aiming Process

After establishing their natural alignment, cadets are now ready to move along to the actual sequence of aiming. The aiming process is as follows:

- a. Adopt a comfortable position;
- b. Make sure the alignment with the target is adequate;
- c. Verify the size of the front aperture; and
- d. Follow the procedures described in paragraphs 7.3.5 and 7.3.6.

During the first attempts to fire in the kneeling position, the rifle will move. This is normal for a beginner.

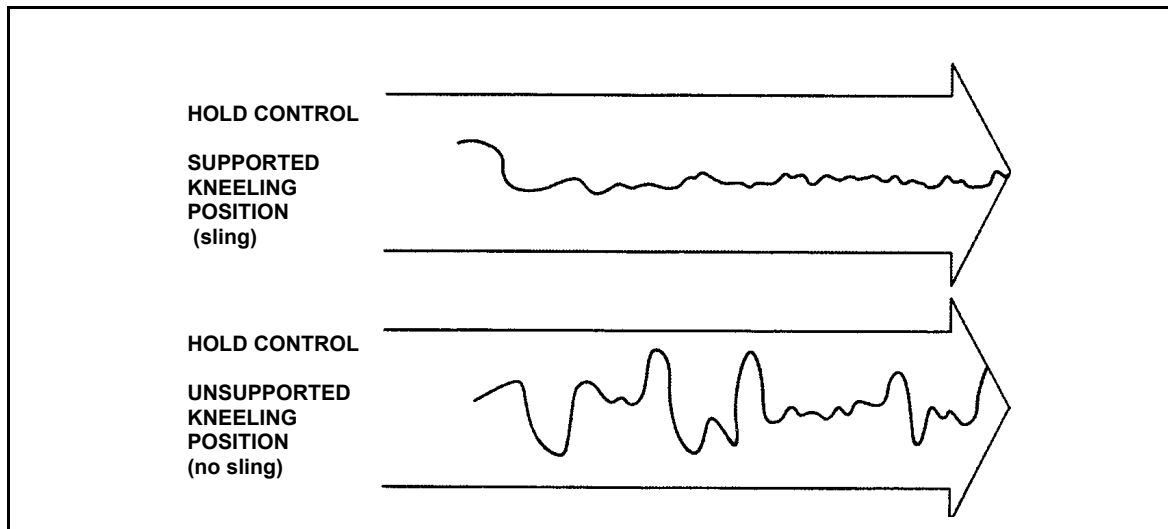



## 7.4 BREATHING

### 7.4.1 Importance of Breathing

Once a stable position is established, cadets must integrate the principles of breathing. While breathing, the oxygen inhaled is used to supply muscles with energy, ensuring optimal potential of these muscles. This includes the muscles that are involved in the position, as well as the muscles in the eyes.

For maximum stability when firing, cadets will have to stop breathing for a few seconds. It is of the utmost importance that they do not hold their breath for more than seven (7) seconds, as the tension will increase in their chest muscles and reduce stability.

### 7.4.2 The Breathing Cycle

In order to achieve a proper breathing sequence, the information in the following graph should be adhered to:

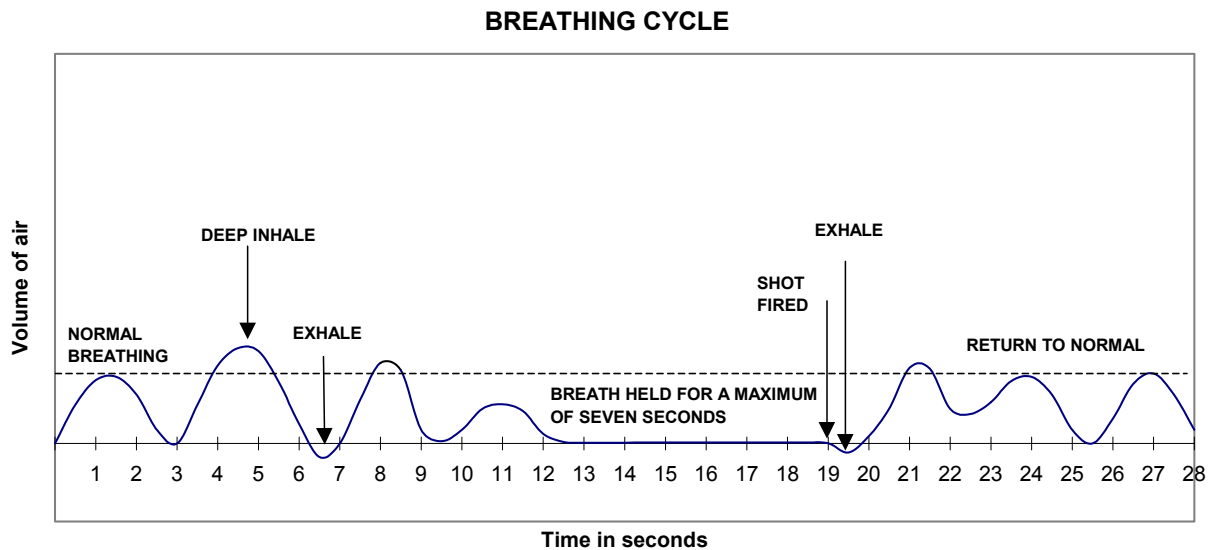

Breathing should be relaxed and normal as cadets establish a sight picture. Then, they should inhale and exhale deeply, take another deep inhale, exhale normally, and completely release their chest muscles and hold their breath. After the shot, a small exhale is followed by normal breathing, and the cycle is repeated.

## 7.5 TRIGGER CONTROL

### 7.5.1 Controlling Trigger Pressure

The following criteria should be followed when squeezing the trigger:

- a. **Position of the Hand on the Rifle.** Cadets should have a relatively firm grip on the small of the butt with the bottom three (3) fingers of their hand. They should not strain their hand and they should make sure the pressure they apply is consistent for every shot. The thumb should point forward and rest in a relaxed position behind the rear sight along the rifle stock or should wrap around the small of the butt.

- b. **Trigger Finger Position.** The index finger should be placed on the trigger halfway between the tip of the finger and the first joint. The index finger never touches the stock of the rifle and must be vertically centered on the trigger.
- c. **Squeezing the Trigger.** Trigger pressure should only be applied when the cadet is ready to fire. It must be applied straight to the rear by bending the second joint of the index finger. Cadets should make sure the pressure they apply is constant and that they slowly squeeze the trigger while they are holding their breath. The trigger of the Daisy 853C air rifle has one stage and its weight is not adjustable.

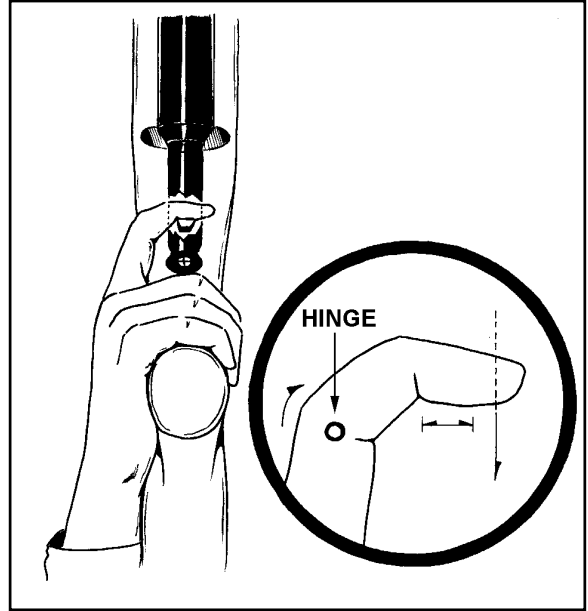

## 7.6 FOLLOW-THROUGH

### 7.6.1 General

Follow-through is essential to firing perfect shots. It is defined as the act of remaining in position for a few seconds after the pellet's departure and it requires both physical and mental effort. It aids in developing proper hold of the rifle, maintaining stability, ensuring that there is no movement of the rifle as the shot is being fired, and calling the shot after it is fired.

If the position is stable, the aiming picture should return to the same place it was before the vibrations caused by the release of compressed air. If this sight picture differs from the initial sight picture, some improvements to the cadet's position need to be done.

## 7.7 LOADING, FIRING AND UNLOADING

### 7.7.1 Pumping the Air Rifle

The following guidelines should be adhered to when pumping the air rifle:

- a. Do not pump the rifle more than once per shot. This air rifle is designed to withstand the pressure based upon a single pump stroke;
- b. If the air rifle is pumped more than once, or left with a full chamber pressure for an extended period (i.e., one hour), the compressed air may not expel completely upon firing. Consequently, the air rifle may have sufficient pressure remaining in the air pressure chamber to fire another pellet. Therefore, a proper unload drill must be done each time a session of firing is completed; and
- c. The cadet must pump the rifle before loading a pellet.

### 7.7.2 Loading the Air Rifle

The following steps should be followed when loading the rifle (the rifle should always point toward the target):

- a. Pick up and hold the rifle with the left hand;
- b. Ensure the safety catch is in the ON position;
- c. Pump the rifle. This can be done effectively in two (2) different ways as described in paragraph 7.7.5;
- d. When the pump handle is fully extended, pause for about three (3) seconds (this is very important; if done incorrectly, the rifle will have insufficient air pressure);

- e. Bring the pump lever back to the closed position (watch the fingers!);
- f. Load a pellet or a five (5) pellet clip; and
- g. Close the bolt.

### **7.7.3 Firing the Air Rifle**

The following actions should be performed in order to fire the rifle (the rifle should always point at the target):

- a. When the RSO gives the command, place the safety catch in the OFF position;
- b. Aim the rifle at the target;
- c. Squeeze the trigger;
- d. Open the bolt, pump the rifle, re-load, aim and fire;
- e. Repeat the last step until firing is completed;
- f. Upon completion, open the bolt, place the safety catch in the ON position, open the bolt and partially open the pump lever; and
- g. Lay the rifle down.

### **7.7.4 Unloading the Air Rifle and Preparing for Inspection**

These steps should be followed when unloading the rifle (the rifle should always point at the target):

- a. Pick up the rifle;
- b. Remove the five (5) pellet clip (if used);
- c. Pump the rifle (hold for three (3) seconds and close);
- d. Move the bolt forward (do not insert a pellet);
- e. Place the safety catch in the OFF position;
- f. Aim the rifle at the target;
- g. Squeeze the trigger;
- h. Open the bolt;
- i. Place the safety catch in the ON position;
- j. Open the pump lever slightly;
- k. Place the rifle on the shoulder, muzzle pointed down range;
- l. Wait to be cleared by the RSO; and
- m. Lay the rifle down.

### 7.7.5 Pumping the Air Rifle

There are two (2) effective ways of pumping the rifle. The first and preferred one can be done by the cadet while the second one requires assistance from a coach. Even though the individual method may seem difficult and complicated, it can be easily performed by any cadet.

To pump the rifle, the cadet should follow these steps:

- a. Remove the butt from the shoulder and ensure a firm grip on the rifle;
- b. Partially open the pump lever with the right hand;
- c. Return the right hand to the small of the butt;
- d. Grasp the pump lever with the left hand, halfway up the lever;
- e. Lift the rifle upwards until the pump lever is fully extended (keep the left elbow in position on the left knee);
- f. Pause for three (3) seconds when the pump lever is fully extended;
- g. Bring the rifle down, thereby returning the pump lever to the closed position;
- h. Load the pellet or the five (5) pellet clip; and
- i. Move the bolt forward.

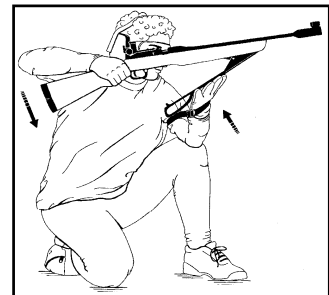

## SECTION 8

### RANGES AND RANGE PROCEDURES

#### 8.1 GENERAL SAFETY

Air rifles may only be fired on a properly prepared air rifle range. The principle dangers found on an air rifle range are:

- a. The ricochet of pellets after they strike a reflecting surface; and
- b. Improper firearms handling.

It is the responsibility of the RSO to ensure that the range is safe and meets all range requirements. It is essential that no part of the pellet stop area may cause a pellet to ricochet.

Each cadet should be provided an area 1.25 metres wide and 2.5 metres (8.2 ft) long when firing in the prone position.

#### 8.2 PORTABLE RANGE SET-UP AND MAINTENANCE

The marksmanship CATO, specifically the annexes on ranges and security should be consulted for all the technical details relevant to this chapter.

##### 8.2.1 General

The following items are required to set up a portable air rifle range:

- a. Area 15 metres long with controlled access;
- b. Numbered target backstops and firing lanes;
- c. Flags (red and green);
- d. First aid kit and stretcher;
- e. Clock and stopwatch (required for competitions);
- f. Appropriate mats;
- g. Spotting scopes;
- h. Hearing protectors;
- i. Safety glasses;
- j. Targets;
- k. Pellets; and
- l. Hand washing facility.

### **8.2.2 RSO Duties**

The RSO must accomplish the following duties:

- a. Prepare the range;
- b. Inspect the range for possible hazards;
- c. Ensure the firing line is ten (10) metres from the targets;
- d. Task and brief range staff;
- e. Control required flags or control lights, and sentries;
- f. Ensure administration requirements are met (i.e., rations and ammunition); and
- g. Fill logbook and registers as required.

#### **NOTE**

See Air Rifle RSO Course Precis for further instructions on range set-up/conduct.

### **8.2.3 Backstops**

There are two (2) possible types of backstop:

- a. Portable target backstops; and
- b. Permanent range backstops.

### **8.2.4 Maintenance**

The range must be cleaned after each use and the lead disposed of as hazardous waste. The pellet stop must be inspected regularly to ensure that deterioration has not occurred.

### **8.3 RANGE TYPES**

The following range types may be used:

- a. Existing indoor ranges;
- b. Temporary indoor ranges;
- c. Existing outdoor ranges; and
- d. Temporary outdoor ranges.

#### **NOTE**

When outdoor ranges are used, environmental effects (in particular wind) must be taken into consideration.

### 8.3.1 Existing Indoor Ranges

Please note that indoor ranges that are not certified for support of smallbore firearms may still be used with air rifles. Air rifles do not use primers or propellants, which are the main source of lead contamination for indoor ranges. The appropriate range certifying authority should be consulted in advance to prevent misunderstandings.

### 8.3.2 Temporary Indoor Ranges

Any room or building exceeding 15 metres in length may be adapted to become a temporary air rifle range (see appropriate CATO).

### 8.3.3 Existing Outdoor Ranges

The following precautions will be observed when firing air rifles on open outdoor ranges:

- a. The target area backstop and sidewalls (if required) will be three (3) metres high; and
- b. The danger area template will be 250 metres in depth and extend 50 mils (2.8°) from the centre line of each firing point.

### 8.3.4 Temporary Outdoor Ranges

Enclosed temporary outdoor ranges constructed from modular tenting may be used. Open temporary outdoor ranges must have a danger area template of 250 metres in depth and extend 50 mils (2.8 degrees) from the centre line of each firing position.

## 8.4 RANGE COMMANDS AND PROCEDURES

### 8.4.1 Range Commands

The following range commands will be given by the RSO and must be learned by cadets before they fire on a range:

COMMAND	ACTION
<b>“Cover off your firing point”</b>	Stand up, move behind the firing point and await further commands.
<b>“Place your equipment down and stand back”</b>	Lay the equipment down on the mat and stand back when finished.
<b>“Adopt the prone position”</b>	Adopt the prone position, pick up the rifle, ready the equipment and put on hearing and eye protection.
<b>Type of firing</b>	This command includes information about the range and type of firing. i.e., Relay #__, ten (10) metres, five (5) rounds, Grouping, On Your Own Time...

COMMAND	ACTION
<p><b>“Relay, load, commence firing”</b></p>	<p>Pick up and hold the rifle with the left hand;                      Ensure the safety catch is in the ON position;                      Pump the rifle;                      When the pump lever is fully extended, pause for about three (3) seconds;                      Load the pellet;                      Close the bolt;                      Place the safety catch in the OFF position; Aim the rifle at the target.                      Squeeze the trigger;                      Open the bolt;                      Repeat the sequence for each shot;                      Place the safety catch in the ON position and partially open the pump lever immediately after firing the practice; and                      Lay down the rifle.</p>
<p><b>MAY BE GIVEN</b></p>	
<p><b>“Relay, cease fire”</b></p>	<p>Stop firing immediately, put the safety catch in the ON position and lay the rifle down.</p>
<p><b>“Relay, resume fire”</b></p>	<p>Put the safety in the OFF position and continue the practice.</p>
<p><b>“Relay, unload and prepare for inspection”</b></p>	<p>Pick up the rifle;                      Remove the five (5) pellet clip if used;                      Pump the rifle;                      Close the bolt;                      Place the safety catch in the OFF position;                      Aim rifle at target;                      Pull the trigger;                      Open the bolt;                      Place safety catch in the ON position;                      Open the pump lever 5-8 cm;                      Place the rifle on the shoulder, muzzle pointed down range;                      Wait to be cleared by the RSO;                      Lay the rifle down; and                      Remove your hearing and eye protection.</p>
<p><b>“Relay, stand up”</b></p>	<p>Stand up and leave the equipment on the ground.</p>
<p><b>“Change targets”</b></p>	<p>Move forward, walk down the lane to remove old targets and replace them with new ones. Return to the firing point.</p>
<p><b>“Change relays”</b></p>	<p>Cadets who have just fired pick up their personal equipment and move off the firing point. The new relay covers off behind the firing point.</p>



## SECTION 9

### TARGET AND SCORING

#### 9.1 TARGETS

##### 9.1.1 General

Pellets will only be fired at penetrable or light reactive targets designed uniquely for use with air rifle pellets.

Penetrable or paper targets are to be mounted on a soft penetrable board, such as Bristol board or cardboard box material. Large head pins must not be used to secure targets as pellets may deflect off them or shatter the pinheads. Tape, elastics or light small head pins should be used to mount penetrable targets. Targets should be placed at the same level as the individual's shoulder or head.

The distance from the forward edge of the firing point line to the target edge line will be ten (10) metres. No portion of the cadet's body may touch the ground in front of the firing line.

##### 9.1.2 Approved DND Targets

The following are approved DND targets for air rifle use:

- a. Paper penetrable grouping and scoring targets;
- b. Biathlon Canada approved reactive targets;
- c. Competition targets including paper penetrable targets or light reactive targets for use in competitions supported by the Canadian Cadet Movement, the Dominion of Canada Rifle Association (DCRA), the Shooting Federation of Canada (SFC) or their affiliates; and
- d. Light reactive targets such as falling plates, spinners or similar devices when approved by the Regional Marksmanship Officer.

#### 9.2 SCORING

##### 9.2.1 General

The following points must be taken into account when scoring a target:

- a. All shot holes are scored according to the highest value of the ring that is touched by the hole. If two (2) scoring rings are touched, the pellet must be scored at the higher value of the two (2) rings;
- b. Hits outside the scoring rings are scored as misses and are given a value of zero (0); and
- c. If the value of a shot is in dispute, the value is determined by means of a scoring template, magnifier or scoring plug.

##### 9.2.2 Scoring Devices

There are four types of scoring devices currently in use in the CCM:

- a. Grouping template;
- b. Scoring magnifier;

- c. Scoring plug; and
- d. Scoring template.

**Grouping Template (see Annex B)**

A grouping template is a series of grouping circles engraved or printed on transparent material. It is used to confirm the diameter of a grouping fired during familiarization or classification firing. The grouping template consists of two (2) parts:

- a. a series of grouping circle outlines, with diameters from one (1) cm to six (6) cm inclusive; and
- b. an outline of an air rifle application target that may be superimposed over a grouping so that a score may be assessed.

It is very important to correctly and consistently measure grouping targets with the grouping template. When evaluating grouping targets, all five (5) shots must lay inside the grouping circle being evaluated. If the group touches the grouping circle, the next sized circle should be used until all five (5) shots lay inside the grouping circle.

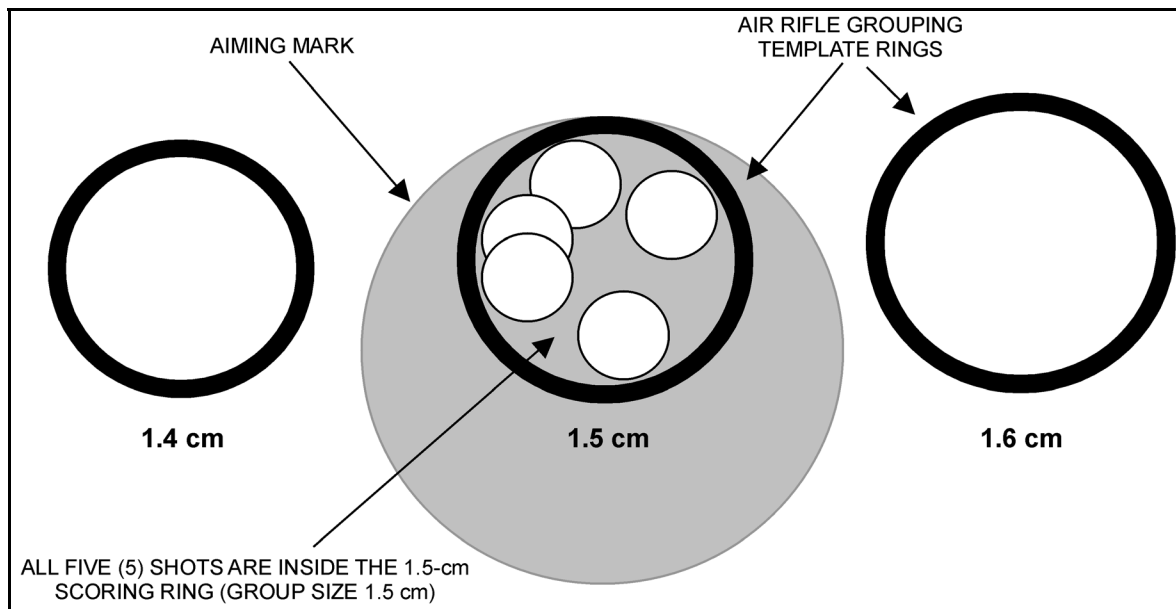

**Scoring Magnifier**

A scoring magnifier is a magnifying overlay that can be used for close viewing of a shot hole. This device does not affect the shot hole. The device has engraved ring(s) the diameter of a pellet which is placed over the pellet hole. The engraved ring is centered over the pellet hole, and the engraved ring is used to determine if the shot hole touches the scoring ring.

- a. Shots which do not touch the scoring ring receive the lower value in score;
- b. Shots which touch or are tangent to the scoring ring receive the higher value in score; and
- c. Shots which break the scoring ring receive the higher value in score.

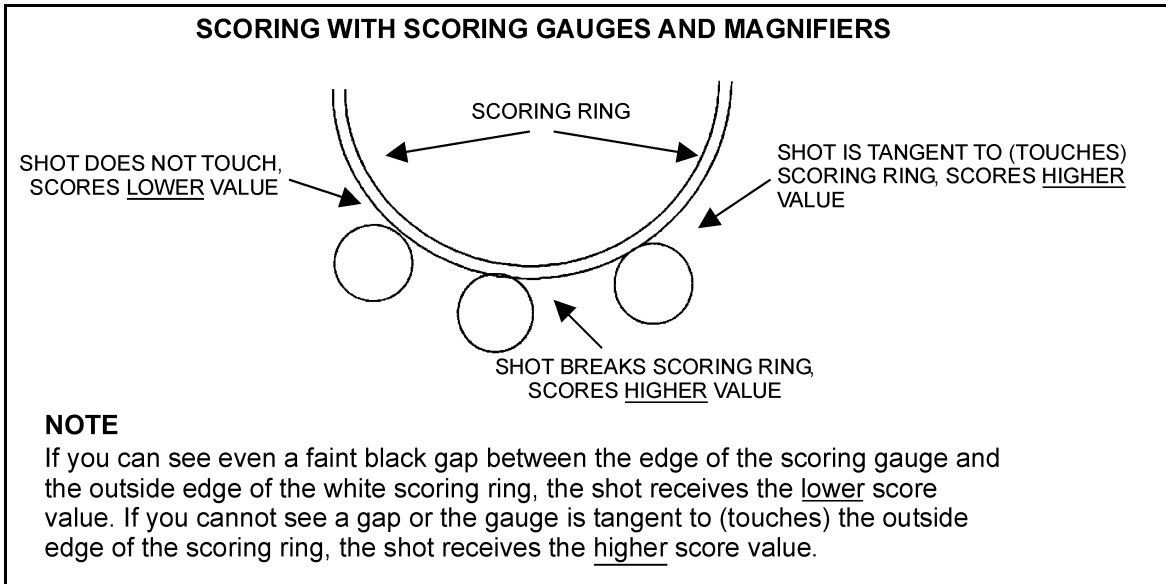

**Scoring Plug**

A scoring plug is a device with a clear plastic flange which can be inserted into a shot hole, with the flange being used to magnify the area around the hole. This gauge will affect the pellet hole and consequently may only be used once in any shot hole. When a scoring plug is used on a shot hole, it should be marked as "PLUGGED". Once a shot hole is scored using a scoring plug, it should not be subject to a scoring plug again.

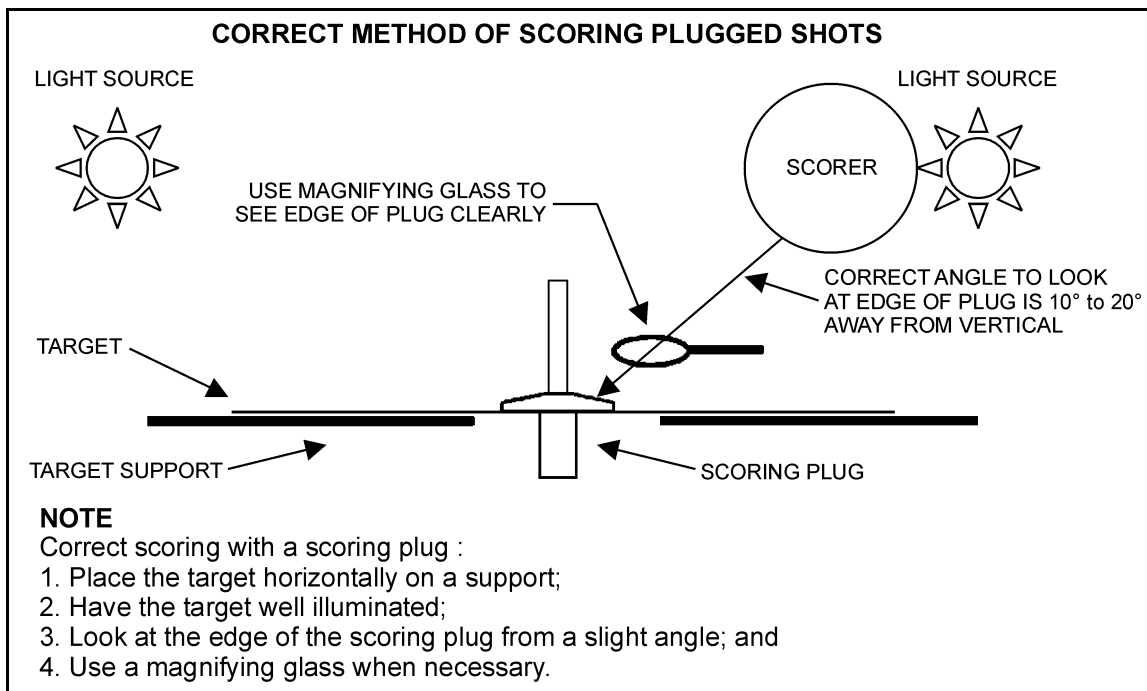

**Scoring Template**

A scoring template consists of transparent material engraved or printed with outlines of the pellet diameter and possible scoring rings. It is used to reconstruct the positions of the scoring ring and shot holes. It is used primarily in matches where multiple shots are fired on individual targets and the scoring rings can potentially be removed during the course of fire.



## SECTION 10

### CLEANING

No one should attempt to clean a rifle until individual safety precautions have been performed on the rifle and it is certain that the barrel is clear of any obstructions.

#### 10.1 CLEANING THE BORE

##### 10.1.1 General

A dirty bore will eventually cause accuracy problems. Many inaccuracy complaints can be traced back to dirty bore usage. Therefore, air rifles must be cleaned and maintained on a regular basis in order to ensure sustained accuracy.

Although air rifles do not suffer from powder deposits as do smallbore and largebore rifles, they do however, experience a build-up of residue in the barrel. This residue takes two (2) forms: leading and caking. "Leading" residue results from traces of lead pellet that are left inside the bore as the pellet travels down the barrel. "Caking" results when residue from compression chamber air blown into the bore condenses in the barrel.

It is important to note that air in the compression chamber will be super heated for a fraction of a second during the firing sequence. This can cause "dieseling" – the detonation of the lubricant inside the chamber. Only high flash point lubricants (i.e., SAE 30 motor oil) are approved for use on air rifles and are to be used for their cleaning and maintenance.

##### 10.1.2 Cleaning Pellets

The 0.177 calibre felt cleaning pellets are simply inserted into the chamber and fired in the same manner as a normal pellet. Felt cleaning pellets are stamped to the optimum diameter for cleaning the bore. The natural elasticity of the felt results in compression of the pellet during firing, forcing it to expand to the diameter of the barrel, and thus ensuring that the entire bore is cleaned and polished. When conducting preservation maintenance, the natural absorbency of felt allows it to hold oils and lubricants, resulting in an even, protective film throughout the barrel.

##### 10.1.3 Before and After Firing Cleaning

Before and after firing, two (2) to three (3) felt cleaning pellets should be fired through the bore to ensure it is clean.

##### 10.1.4 Periodic Cleaning

The bore must also be thoroughly cleaned after every 1000 shots fired.



Petroleum-based cleaners or preservatives must not be used. These solvents will damage seals and may result in dieseling. Use only SAE 30 motor oil.

The following steps should be followed for periodic cleaning:

- a. Fire a felt cleaning pellet soaked in SAE 30 motor oil and wait five (5) minutes; and
- b. Fire three (3) felt cleaning pellets.

**10.1.5 Cleaning Before Storage**

For purposes of preservation and bore deterioration prevention, a rifle that is to be stored over a three (3) month period of time or longer should have two (2) or three (3) felt pellets as well as a felt pellet soaked in SAE 30 motor oil fired through its barrel. No other felt pellets should be fired as the oil should remain in the barrel.

<b>CLEANING THE BORE</b>	
<b>When</b>	<b>Action</b>
Before firing	Fire 2-3 felt cleaning pellets.
After firing	Fire 2-3 felt cleaning pellets.
Periodic	1) Fire a felt cleaning pellet soaked in SAE 30 motor oil; 2) Wait five (5) minutes; and 3) Fire three (3) felt cleaning pellets.
Storage of three (3) months or longer	1) Fire 2-3 felt cleaning pellets; 2) Fire one (1) felt cleaning pellet soaked in SAE 30 motor oil; and 3) Fire three (3) felt cleaning pellets when taking rifle out of storage.

**10.2 CLEANING OF OTHER PARTS**

**10.2.1 Stock**

The stock should be frequently wiped clean with a damp cloth.

**10.2.2 Exterior Metallic Parts**

The exterior metallic parts of the rifle should be cleaned on a regular basis with the aid of a lightly oiled flannel patch. The pivot points should also be **lightly** lubricated on a regular basis.

## SECTION 11

### MAINTENANCE

Rifles will only be taken apart to carry out authorized repairs as needed. Unnecessary stripping will only contribute to premature wear of the rifle parts.

#### 11.1 TYPES OF MAINTENANCE

There are three (3) types of maintenance on air rifles that will be conducted at the unit level. They are:

- a. Before firing maintenance;
- b. After firing maintenance; and
- c. Storage or preservation maintenance.

##### 11.1.1 Before Firing Maintenance

Before firing maintenance is conducted at the start of each training session. It consists of:

- a. A general inspection of the rifle to ensure its sights are properly attached, its screws are tight, and it is clean and functioning properly; and
- b. Under the direction of the RSO, two (2) or three (3) felt cleaning pellets will be fired through the barrel to ensure it is clean.

##### 11.1.2 After Firing Maintenance

After firing maintenance is conducted at the end of each training session. It is intended to ensure the rifle is clean, functioning, and will be ready for the next training session. It entails the following:

- a. Under the direction of the RSO, two (2) or three (3) felt cleaning pellets will be fired through the barrel; and
- b. All external parts of the rifle will be cleaned.

##### 11.1.3 Storage or Preservation Maintenance

Storage or preservation maintenance will be conducted at any time when a rifle is stored for more than three (3) months without firing. It consists of:

- a. The general cleaning of the exterior parts and **light** oiling of all exposed metal parts; and
- b. The firing under controlled conditions of:
  - (1) a felt cleaning pellet through the barrel;
  - (2) a felt cleaning pellet soaked in SAE 30 motor oil through the barrel; and
  - (3) three (3) felt cleaning pellets when taking the rifle out of storage.

#### 11.1.4 Pump Piston Lubrication

The piston should be lubricated after every 1000 pellets fired. To lubricate the piston:

- a. Turn the rifle upside down;
- b. Open the pump lever to full extension; and
- c. Insert **one (1) drop** of SAE 30 motor oil in the place indicated "OIL HERE".

#### NOTE

Do not saturate the piston with oil. Usage of a non-recommended oil is dangerous and can damage the mechanism. Use only high flash point lubricants.

### 11.2 DISASSEMBLING THE RIFLE

#### 11.2.1 General

Prior to disassembling a rifle, ensure that you have a clean working area. The video produced by Daisy Manufacturing and distributed by the CCM is a good reference tool for disassembling and reassembling the rifle.

#### NOTE

Malfunctioning rifles can be returned to the Local Cadet Detachments and exchanged for functioning rifles. No one should attempt to repair a rifle unless they are confident they are able to perform this task.

The following tools and supplies are required to disassemble and reassemble the Daisy 853C rifle:

- a. Clean, lint free rags;
- b. SAE 30 motor oil;
- c. General purpose grease;
- d. Two (2) No. 2 Phillips screwdrivers;
- e. One (1) small flat-blade screwdriver;
- f. One (1) 1/4 in. open end wrench; and
- g. One (1) 1/8 in. pin punch, two in. long.



## 11.2.2 Disassembly

The following steps should be followed when disassembling the Daisy 853C air rifle:

### Disassembly of the stock from the bared action

- a. Pull the bolt back and remove the single pellet adapter;
- b. Remove the two (2) Phillips screws from the fore end of the stock. It may be necessary to use two (2) screwdrivers if the nuts turn in the stock. Once the screws are removed, use the 1/8 in. punch to push the nuts out of the stock. Remove the spacer held in place by the rear screw;

### NOTE

The nuts are always inserted from the right side of the stock.

- c. Remove the screw at the rear of the trigger guard. If it does not come all the way out, leave it for later removal;
- d. Extend the pump lever to the forward position and turn the rifle upside down;
- e. Place the safety catch midway between safe and fire to provide clearance with the stock;
- f. Push down on the trigger guard with your thumb until it clears the stock. Place your other hand midway along the stock to catch the fillers as the action clears the opening. When the rear of the action is clear, move the stock slightly forward and remove it over the pump lever;
- g. Remove the fillers and the barrel band;
- h. Push the spacer out from between the barrel and frame;

### Disassembly of the receiver

- i. Remove the two (2) receiver screws. The receiver is removed by rotating the rear of it upwards with your thumb. Make sure you control the bolt handle as it is under spring pressure. Lift the receiver clear and remove the bolt handle and spring;
- j. Pull back on the trigger lock lever and remove the bolt, being careful not to damage the thin portion on the front;

### Disassembly of the pump and valve assembly and verification of the o-rings

- k. With the aid of a flat-blade screwdriver, pry out the two (2) tabs on either side at the rear of the frame just far enough to clear the valve body. Slide the frame forward to remove it;
- l. Remove the lever axis pin and slide the frame clear of the pump lever assembly;
- m. If the plunger must be replaced, remove it from the lever assembly by pushing the connecting pin out using a small punch. During reassembly, ensure that the connecting pin does not protrude from either side of the plunger;
- n. Slide the frame over the plunger and replace the lever pin;

- o. To disassemble the valve group, first remove the pump tube by sliding it forward over the o-ring. Then move the flat retainer to the side until it clears the protrusion that holds it in place. It is under spring tension. As the retainer is forced up by the spring, it will be stopped when the spring contacts the inner shoulder of the retainer. A little manipulation is now necessary to remove the retainer over the spring; and

#### **NOTE**

It is absolutely necessary that this area be kept clean. Any dirt entering this area will cause premature failure.

- p. The o-ring and valve assembly can be replaced as necessary if pressure is leaking and the muzzle velocity drops during firing.

### **11.3 REASSEMBLING THE RIFLE**

#### **11.3.1 Reassembling**

The following steps should be followed to reassemble the Daisy 853C air rifle:

##### **Reassembling the pump and valve assembly**

- a. Lightly oil the valve and insert it into the valve body along with the spring. Insert the rectangular extension of the valve retainer under the lip at the valve opening. Push the retainer down against the spring tension until it is fully seated and held in position by the protrusion on the valve body, thereby engaging the hole in the retainer;
- b. Replace the pump lever latch by pushing it down and forward against the spring compression until it clips into its recess;
- c. Place the pump tube over the front end of the valve body with the deep “V” groove pointing towards the muzzle. Carefully work the tube over the o-ring so as not to damage it. Align the small groove in the tube with the protrusion on the valve body and push the tube into place;
- d. The frame and pump lever is replaced as an assembly. Place the frame over the pump tube and slide it to the rear. Carefully work the o-ring and wiper into the tube so as not to damage them. When they are inside the tube, move the pump lever forward. The frame will slide to the rear. Align the tabs on the frame with the protrusions on the valve body and squeeze them into place;

##### **Reassembling the receiver**

- e. Raise the trigger lock lever and replace the bolt by first inserting the long protrusion into the chamber. Slide the bolt down and forward into place. The bolt handle and spring can now be replaced on the bolt;
- f. To put the receiver back into place, push the prongs on the front end over the barrel and into the slots on top of the frame. Hold the bolt handle in place and rotate the receiver down over the valve body until the screw holes are aligned. Replace the screws;

- g. Replace the combination screw and nut behind the trigger guard and tighten it with the 1/4 in. wrench;

**NOTE**

Overtightening could cause damage to the soft metal of the valve body.

**Reassembling the bared action with the stock**

- h. Replace the spacer between the barrel and frame;
- i. Replace the barrel band, aligning the screw holes with those in the frame;
- j. Replace the fillers, aligning the screw holes with those in the barrel band and frame. The small tabs at the rear fit into the slots in the receiver;
- k. Hold the fillers together and slide the pump lever through the opening in the stock. Slide the action all the way forward. Centre the safety catch and slide the action down into the stock;
- l. Insert the 1/8 in. punch into the front screw hole in the stock, and wiggle it around to align all components. The screw is inserted from the left side, and the nut from the right;
- m. Insert the rear stock spacer with the flat portion away from the action and the screw hole aligned with those in the stock. The screw is inserted from left to right;

**NOTE**

Overtightening the screws may damage the stock.

- n. Replace the half moon spacer and screw at the rear of the trigger guard; and
- o. Return the pump lever to the latched position.

**11.3.2 Functioning Tests After Re-assembly**

After reassembling the rifle, a functioning test needs to be performed in order to verify that the rifle has been put back together correctly. The function test is carried out in two (2) steps as follows:

- a. **Safety Catch/Pump Assembly Test.** Pump the rifle, pull back the bolt, load a cleaning pellet, place the safety catch to ON, and pull the trigger. The rifle should not fire. Place the safety catch to OFF and pull the trigger. The rifle should fire.
- b. **Feed Action Test.** To verify the functionality of the feed action, insert a five (5) pellet clip in the rifle. Pull back the bolt, push it forward and pull the trigger while observing the feed action of the clip (pumping and pellets are not required).

**11.3.3 Checklist**

The following checklist will help in disassembling and reassembling the rifle by ensuring that all the necessary steps are completed.

ITEM	COMPLETED
<b>Disassembly</b>	
1) Remove the single pellet adapter	
2) Remove the stock from the barrelled action	
3) Disassemble the fillers	
4) Disassemble the barrel band	
5) Disassemble the spacers	
6) Disassemble the receiver	
7) Remove the bolt handle and the spring	
8) Remove the bolt	
9) Remove the frame	
10) Remove the pump assembly	
11) Remove the plunger	
12) Remove the pump lever latch	
13) Remove the valve group	
<b>Maintenance</b>	
1) Verify the condition of the plunger's o-ring and felt washer and replace or lightly oil them if required	
2) Verify the condition of the plunger and replace it if required	
3) Verify the condition of the pump cylinder's o-ring and felt washer and replace or lightly oil them if required	
<b>Reassembly</b>	
1) Replace the valve	
2) Replace the plunger	
3) Replace the pump lever latch	
4) Replace the pump assembly	
5) Insert the bolt	
6) Insert the bolt handle and the spring	
7) Reassemble the receiver	
8) Reassemble the spacers	
9) Reassemble the barrel band	
10) Reassemble the fillers	
11) Reassemble the barrelled action in the stock	
12) Reassemble the single pellet adapter	
13) Lubricate the pump piston foam wiper ring	
14) Lubricate the pump lever pivot points	
<b>Test After Reassembly</b>	
1) Verify the correct functioning of the safety catch and the pump assembly	
2) Verify the correct functioning of the feed mechanism	

## SECTION 12

### INTRODUCTION TO COACHING

#### 12.1 GENERAL

The role of a coach is to aid, assist, teach and help improve a cadet's performance. A good coach's marksmanship skills can be successfully taught to an individual (i.e., skills, knowledge, enthusiasm, encouragement, positive attitude, and concentration) and will result in an improved marksmanship performance. A good coach is able to recognize and improve imperfections in position, holding and firing.

#### NOTE

When a verbal explanation or direction is insufficient, it may be necessary to physically adjust a cadet's position or to monitor breathing. Coaches must inform the individual of the actions they are about to take, and request permission to do so.

#### 12.2 DUTIES

A coach's duties include:

- a. Providing positive reinforcement;
- b. Instilling self-confidence;
- c. Maintaining a coaching diary;
- d. Correcting marksmanship principles and techniques;
- e. Correcting position problems;
- f. Analyzing targets; and
- g. Dedicating time and energy to cadets.

#### 12.3 FIRING POINT SEQUENCE

Coaches should take the following actions on the firing point:

- a. Position themselves on the right hand side of the cadet (left side for a left-handed individual) or at the back of the firing lane in the best position to observe without disturbing the individual or their position;
- b. Ensure that the cadet is lined up on the correct target and that the rear sight is correctly set and centered;
- c. Observe the individual's natural alignment. If necessary, adjust their:
  - (1) position;
  - (2) hold (coaches should be particularly aware of possible canting – when the cadet fires the rifle while it is tilted to the side);

- (3) eye relief;
  - (4) breathing sequence; and
  - (5) trigger squeezing; and
- d. Encourage the individual to relax and to rest during his relay.

## 12.4 COMPETITION FIRING

### 12.4.1 Cadet Coach

A cadet coach is defined as any cadet who has been appointed by the adult coach to carry out coaching duties while on the firing point. The following guidelines apply to cadet coaches while in competition:

- a. The cadet coach is permitted to coach on the firing point;
- b. The cadet coach may assist the competitor in cocking the Daisy 853C while on the firing point;
- c. The cadet coach may not touch the competitor or support their rifle while aiming or firing;
- d. The cadet coach may assist the competitor in adjusting their sights; and
- e. Verbal communication with competitors is not permitted during competitions.

### 12.4.2 Adult Coach

An adult coach is defined as a member of the CF or a CI responsible for the cadets. An adult coach is not permitted to coach while a cadet is on the firing point during a competition. The coach may, however, observe from the coaches box, situated at the rear of the range.

## 12.5 ANALYSIS OF COMMON ERRORS

The coach must help the cadet in understanding their errors and teach them how to properly correct them. The following diagrams illustrate eight common errors, and will aid in analyzing specific grouping patterns.

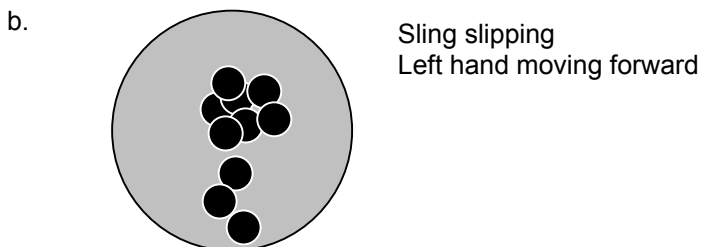
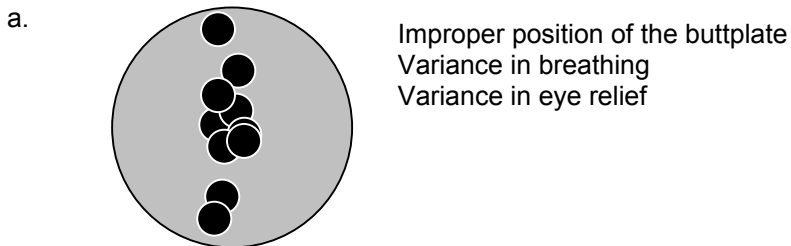

c.

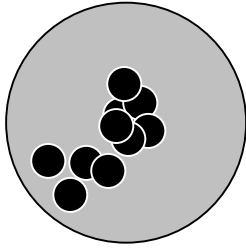

Anticipation of recoil

d.

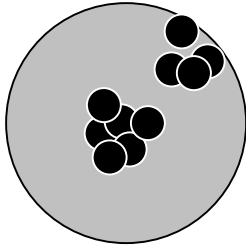

Anticipation of recoil

e.

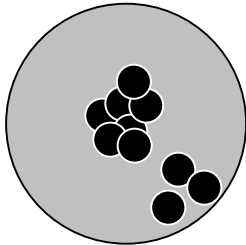

Jerking the trigger

f.

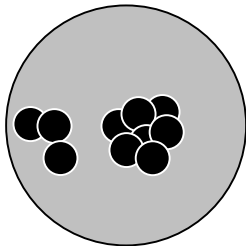

Squeezing the trigger at an angle  
Improper usage of the sling

g.

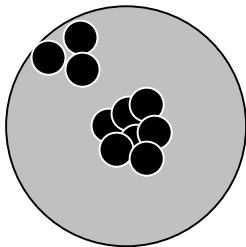

No follow-through or anticipation

h.

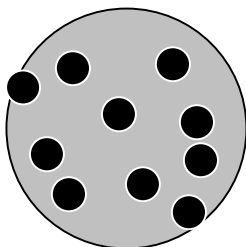

Poor usage of marksmanship principles or barrel  
needs replacing





## SECTION 13

### MARKSMANSHIP EQUIPMENT

#### 13.1 GENERAL

Marksmanship equipment such as jackets, mats, hats, gloves, scopes and slings may be used during practice and competition. Corps and squadrons must ensure that they only use equipment and apparel that complies with the rules of the CCM Marksmanship Championship Series. Prior to the beginning of a competition, each competitor must submit all equipment and apparel to the equipment check for official inspection and approval.

#### 13.2 MARKSMANSHIP APPAREL

##### 13.2.1 General

Cadets performance can be easily improved by providing them with adequate apparel. This apparel will help to increase both stability and comfort.

It is not necessary to purchase equipment that is custom-made for marksmanship. Locally produced apparel is sometimes just as good as more expensive, specialized equipment. For example, it is possible to substitute a ski glove for a marksmanship glove, or to have marksmanship jackets produced by a tailor in the community.

##### 13.2.2 Restrictions

The use of any special devices, means or garments that immobilize or unduly reduce the flexibility of the competitor's legs, body or arms is prohibited. All clothing must be made of soft, flexible and pliable material that does not become stiffer, thicker or harder under normal firing conditions. Adhesives or the use of other materials on the clothing to assist the position are also prohibited.

Certain specifications apply to each type of marksmanship apparel. For exact specifications, see the *CCM Marksmanship Championship Series Rule Book*.

##### 13.2.3 Marksmanship Jacket

A jacket offers some support and helps stabilize the body. Only jackets made of single layer cotton twill are permitted in cadet competitions. Rubber pads are attached to the elbows and to the right shoulder to soften contact with the ground and with the rifle. Another pad can be attached to the left arm in order to support the sling and lessen the pressure caused by it. The jacket must be large enough to permit the wearing of sweaters. The jacket also helps to reduce the pulse felt from the upper arm.

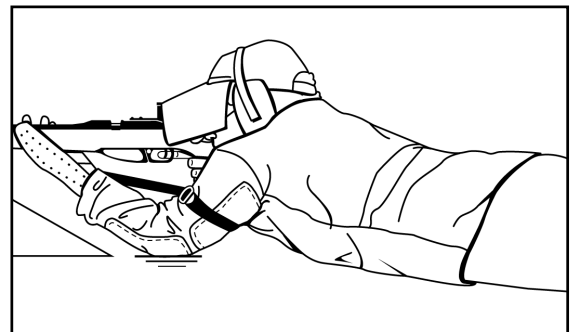

### 13.2.4 Marksmanship Glove

The marksmanship glove protects the back or interior of the hand against pressures created by the sling and the sling swivel. It can either be in the form of a glove or a mitt.

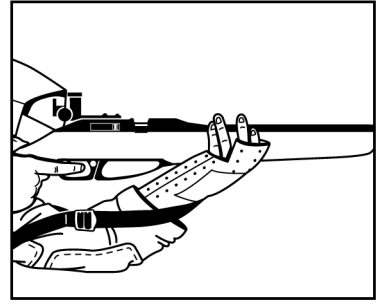

### 13.2.5 Marksmanship Hat

The marksmanship hat has flap sides and an elongated peak, which creates a tunnel vision and helps in avoiding neighbouring distractions.

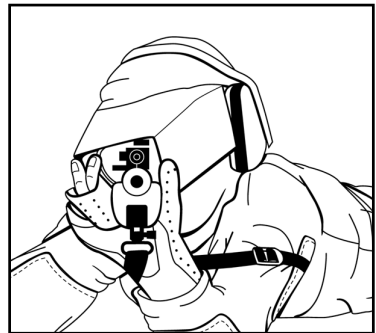

### 13.2.6 Sweaters

It is of the utmost importance to wear at least one sweater under the marksmanship jacket. If possible, two (2) sweaters should be worn. These sweaters increase stability and absorb pulse beat. The marksman must be comfortable and his jacket must be big enough to permit the wearing of sweaters.

### 13.2.7 Sling

The only sling permitted for use in the CCM is the sling issued with the Daisy 853C. The sling helps to support the weight of the rifle, ensuring minimal muscular effort on the part of the marksman.

### 13.2.8 Blinder

A blinder is a vision blocking device, attached to the rifle sight or the competitor's glasses, that is used to help prevent squinting and eye fatigue. The blinder should be translucent or white so that it allows light to pass through it.

### 13.2.9 Telescope

Telescopes are used so that the cadet or coach can view the target and make sight adjustments based on the fired shots. The scope must be mounted off the rifle and it must not act as an artificial support for the marksman.

### 13.2.10 Mats

Mats or ground sheets are used to aid the comfort of the cadets. However, they may not be used to provide an artificial support.

**13.2.11 Table, Chairs or Adjustable Device**

Tables, chairs or adjustable devices are used in the standing and kneeling positions. These aids are used to ensure all equipment (scope, tools, inserts, etc.), pellets and targets are close enough to the cadet so the position is not affected when requiring these items during a course of fire. The table, chair or adjustable device must not act as an artificial support for the cadet.

**13.2.12 Kneeling Roll**

A kneeling roll is placed under the right foot in the kneeling position. The kneeling roll is an optional piece of equipment and some cadets may find it improves comfort and stability in the kneeling position.



## SECTION 14

### PHYSICAL TRAINING

#### 14.1 GENERAL

Physical training improves and develops the strength and endurance required to hold the rifle steady for long periods of time without fatigue. Aerobic training will also improve the cardiovascular system, which in turn will rest the heart rate and improve the efficient transport of oxygen. In short, the higher the level of fitness in an individual, the more consistent, regular and lower their pulse will be.

Obviously, the best way to train the muscle groups that will be used in marksmanship is to carry out live or dry firing exercises.

Before a competition or practice, a warm-up exercise is recommended in order to get the blood flowing and the muscles tuned. Stretching exercises can help the individual's flexibility and level of comfort during the firing session.

#### 14.2 WARM-UP EXERCISES TO BE DONE BEFORE STATIC STRETCHING

While firing, the individual maintains a static position that demands a lot of muscular stamina. A good stretch puts the muscles in movement and warms them up, thereby getting the blood flowing to the muscles that will be used when firing. These exercises will help the cadet keep a stable and comfortable position. Each exercise should last about 20-30 seconds and it is important that cadets not bounce or jerk when doing them.

The following warm-up exercises should be done before stretching:

- a. **Neck.** Standing feet astride, turn the head in semi-circles to the left and to the right.



- b. **Shoulders.** Standing feet astride with the arms by the sides, rotate the shoulders forwards and backwards.

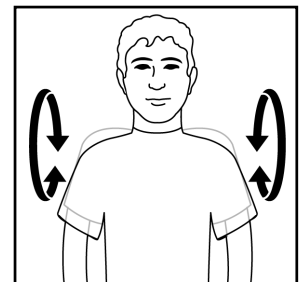

- c. **Trunk.** Standing feet astride with the arms by the side, rotate the trunk to the left and to the right.

**NOTE**

When doing these exercises, do not bend backwards as it is dangerous for their back.

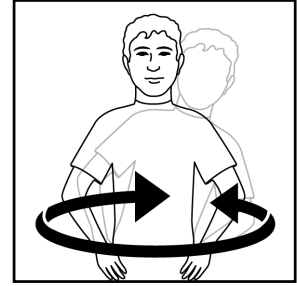

**14.3 STATIC STRETCHING EXERCISES**

Stretching muscles can be compared to stretching an elastic band. In static stretching, the elastic band is stretched slowly. It is a controlled and maintained movement. In dynamic stretching, the elastic band would be pulled and released quickly (bounced). Only static stretching should be done for exercises related to marksmanship. This way, individuals will know to what point their muscles should be stretched while in the firing position.

**14.3.1 Guidelines to Follow When Stretching**

The following stretching exercises are used to increase flexibility, which will in turn facilitate muscle control and relaxation. The exercises presented in this section are called self static stretching exercises since individuals perform their own exercises with a steady force through the joint range of motion, rather than with a bobbing up and down force. The following guidelines should be adhered to when stretching:

- a. Initially it is not important that individuals be flexible. The important point is that they learn how to stretch their muscles properly and develop a liking for the stretching exercise;
- b. Individuals should not compare themselves with others. Genetically, everyone is different;
- c. Stretching exercises are to be done prior to a physical workout, range practice or competition;
- d. Stretching exercises are to be done slowly with no sudden jerks or bouncing;
- e. Individuals should stretch as far as they can until a **slight** burning sensation is felt in the muscle being stretched;
- f. Individuals should concentrate on good technique and form; and
- g. Individuals should try to adopt a flexibility-stretching program to be carried out daily for maximum benefit.

### 14.3.2 Stretching Exercises

The following exercises are advisable to perform before a firing session and should each last for about twenty seconds:

- a. **Head and Neck.** Standing feet astride with the hands on the hips, bend the head forward and bring it back to its original position. Then, bend the head sideways as well as turn it from left to right in slow stretching motions.

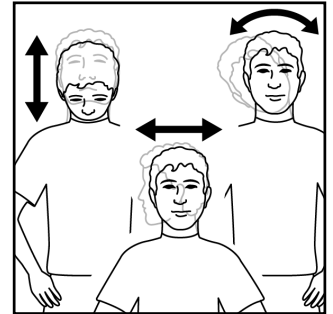

- b. **Shoulders, Arms and Wrists**

Standing feet astride with the arm bent across the chest, pull the arm across the chest with the opposite hand. Repeat this sequence for both arms.



Standing feet astride with the arms raised overhead, hold the left elbow with the right hand. Bend the left hand down between the shoulder blades. Using the right hand, slowly push downward on the elbow. Repeat this for both arms.



Standing with the feet astride and the arms raised forward, using one hand, push the fingers of the other hand backwards. Repeat this exercise for both wrists.

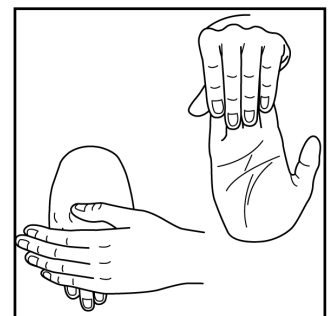

Using one hand, push the fingers of the other hand downwards. Repeat this for the other wrist.

- c. **Back.** For the **upper back**, stand against a wall and pull the knee up to the chest. Hold the knee with the hands and push down. Repeat this sequence with both knees. For the **lower back**, stand while bending the knees slightly and bend down and touch the toes. Bend down as far as possible in a controlled movement and then return to a straight-up position.

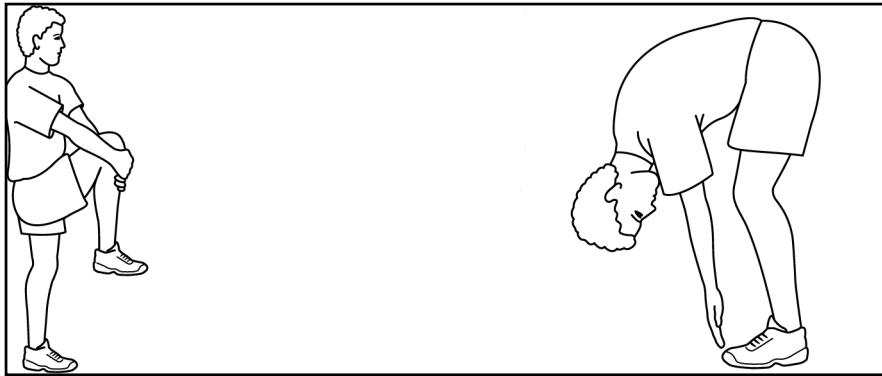

#### 14.4 DIET

Carbonated beverages, coffee and tea contain caffeine, which affects the heartrate and can adversely affect an individual's performance. These drinks should not be taken close to the time of a competition or practice. It is also advisable to eat lightly before a competition or a practice, as eating too much can cause an elevated heartrate and the added discomfort of a full stomach. As dehydration is a common problem, it is strongly advisable to drink liquids such as water or diluted juice prior to a competition.

#### 14.5 RELAXATION TECHNIQUES

##### 14.5.1 General

Stress can cause mental tension that may result in muscle tension. This may in turn cause trembling which will cause the rifle to shake. When muscles are relaxed, the mind will also be relaxed and the heart rate will lower. Relaxation techniques can help the cadet to focus on the firing sequence.

There are many ways that an individual can break the tension experienced during a match, i.e., by taking pauses during the match or by breathing deeply. Being in a relaxed state can greatly improve a cadet's performance.

##### 14.5.2 Relaxation Methods

A very reliable relaxation method involves concentrating on each set of muscles, starting with the muscles in the toes and gradually working up through the body to the facial muscles. This exercise can be done anywhere and will help calm a cadet before a competition. This exercise provides the best results when cadets are performing it while lying on their backs. It should be practised for 10-15 minutes each day and incorporated into an individual's preparation prior to firing. Cadets should concentrate on each muscle, tense it for about ten seconds and then relax it. They should repeat this exercise for each muscle group (always working upward towards face).



Cadets should follow this sequence when doing this exercise:

- a. Curl the toes and then relax them;
- b. Tense up the calf muscles and relax them;
- c. Tense up the thigh muscles and relax them;
- d. Tense up the buttocks and relax it;
- e. Tense up the abdominal muscles (stomach) and relax them;
- f. Curl the arms (biceps) and relax them;
- g. Hyperextend the arms (triceps) and relax them;
- h. Clench the fists and relax them; and
- i. Tense up the face muscles and relax them.

#### **14.5.3 Relaxation Breathing Exercise**

A very effective method to relax the body involves the following breathing exercise:

- a. Cadets sit cross-legged with the palms of their hands open;
- b. Cadets then close their eyes;
- c. Cadets then take ten (10) deep stomach breaths closing one finger for each breath; and
- d. Once all their fingers are closed (ten (10) breaths have been taken), coaches should ask the cadets to slowly open their fingers.

However, the best way to be relaxed when firing is to be prepared. When laying down to fire, cadets should know where all their different pieces of equipment are and should not be worried about forgetting anything or looking around for pellets or ear protection.



## SECTION 15

### MENTAL TRAINING

#### 15.1 GENERAL

Sports psychology has proven extremely beneficial in marksmanship. Attitude, positive outlook and motivation are very important aspects of this sport. This form of training is used to develop methods to control thoughts before, during, and after firing. Sports psychology will help individuals to concentrate on the task at hand and prevent their focus from drifting away from their plan when something unexpected happens.

#### 15.2 MENTAL IMAGERY

The most common form of mental training is called mental rehearsal, mental imagery or visualization, which involves thinking through the act of firing without any physical involvement whatsoever. Mental imagery is very useful and can be done anywhere, although it has proven most effective when performed immediately after relaxation techniques.

In early stages of mental imagery, the cadet should try to envisage the firing of a single shot. The aim should be to imagine, as completely and accurately and in as much detail as possible, a perfect firing sequence, from adopting the position up to the follow-through. If parts of the sequence cannot be visualized, more work needs to be done to perfect this technique. After the sequence has been envisaged successfully, cadets should try to move their body through the sequence as if they were actually firing.

Cadets imagine themselves going through the entire match. This includes match preparation, adopting a good position as well as following the proper sequence required to fire a perfect shot (holding, aiming, breathing, squeezing trigger, follow-through). Each of these steps involves further imagery. For example, in rehearsing trigger control, the individual would concentrate on the placement of their finger on the trigger, the position of their hand on the rifle stock, and trigger release. In performing mental imagery, the cadet must imagine doing the correct procedures. The thoughts must be completely positive, as negative thoughts or incorrect procedures will affect performance.

Mental imagery differs from person to person. It is advised that each individual writes down their firing sequence and develops their own personal mental plan. However, this takes time and patience. Once done correctly, individuals will become more confident when firing because they will be completely comfortable with the procedure, having rehearsed it mentally on numerous occasions. Eventually, firing a match will become second nature to them.

Mental imagery also permits cadets to imagine what they will do if a problem arises while they are firing. For example, if they fire a bad shot, they will be able to put it behind them and concentrate on firing good ones. All thoughts should be positive. Positive thinking leads to positive outcome!



## SECTION 16

### TRAINING PLAN & MARKSMANSHIP DIARY

*Achieving success is often a function of goal setting, establishing a plan and developing a method to evaluate the plan over time.*

#### 16.1 GOALS

Establishing goals is the beginning of a successful marksmanship training plan. Goals are the “road map” to where you want to go in the future. There are three types of goals:

- a. **Long Term Goals.** Long term goals are the rewards you would like to realize in one or more years;
- b. **Medium Term Goals.** Medium term goals are the events you want to realize over one to twelve months; and
- c. **Short Term Goals.** Short term goals are very specific goals and objectives which are realized over a training period or training day. These goals are very specific and detailed. They occur every training session and assist you in realizing your medium term goals.

##### 16.1.1 Establishing Goals Must Be SMART

The term SMART refers to maximizing the potential of goals and ensuring they meet your needs. Goals should be:

- a. **Specific.** Goals must be specific in what you wish to achieve;
- b. **Measurable.** Goals require a method of determining whether or not they have been achieved. Each goal requires a quantitative method to evaluate the success;
- c. **Achievable.** The goals need to be attainable in the set period of time;
- d. **Realistic.** Goals have to be considered against what is possible. It is not realistic to establish a goal such as competing in the Olympics this year if you have never fired a rifle before; and
- e. **Timed.** When establishing your goals, consider the time in which you wish to achieve it successfully. Each goal needs a time limit to determine success.

#### 16.2 TRAINING PLAN

A training plan is a tool to help achieve your goals. By establishing a training plan, you will be able to set out a plan to achieve your long term, medium term, and short term goals.

A calendar is an easy way to record and view your training plan in an easy to view and user friendly format.

### 16.3 MARKSMANSHIP DIARY

The Marksmanship Diary is a tool used by athletes to help in their training. The diary is a detailed record of training events. Diaries take many shapes and sizes. The type of diary is not important, the information it contains is important. Feel free to develop a diary yourself, or use the easy to complete diary below for marksman and coaches.

### 16.4 SAMPLE DIARY SHEET

The diary sheet has been developed specifically for marksman using the Daisy 853C air rifle and the coaches of cadets within the CCM.

CCM Marksmanship Diary					
Date: _____	Location: _____	<input type="checkbox"/>	Standing		
Time: _____	Training/Competition: _____	<input type="checkbox"/>	Kneeling		
		<input type="checkbox"/>	Prone		
<input type="checkbox"/> Rifle Safety Check	<input type="checkbox"/> Elevation Set	<input type="checkbox"/> Right Insert	<input type="checkbox"/> Reviewed Diary	<input type="checkbox"/> First Aid Kit	
<input type="checkbox"/> Safety Rod	<input type="checkbox"/> Windage Set	<input type="checkbox"/> Scope & Stand	<input type="checkbox"/> Shooting Mat	<input type="checkbox"/> Stretcher	
<input type="checkbox"/> Inspect Condition	<input type="checkbox"/> Shooting Jacket	<input type="checkbox"/> Table/Stand	<input type="checkbox"/> Timer	<input type="checkbox"/> Range Flags	
<input type="checkbox"/> Front Sight	<input type="checkbox"/> Shooting Hat	<input type="checkbox"/> Kneeling Roll	<input type="checkbox"/> Targets	<input type="checkbox"/> Barricade	
<input type="checkbox"/> Rear Sight	<input type="checkbox"/> Shooting Glasses	<input type="checkbox"/> Pellets	<input type="checkbox"/> Pen/Paper/Diary	<input type="checkbox"/> _____	
<input type="checkbox"/> Sling	<input type="checkbox"/> Ear Protection	<input type="checkbox"/> Training Goal Set	<input type="checkbox"/> Tools	<input type="checkbox"/> _____	
<input type="checkbox"/> Sling Swivel	<input type="checkbox"/> Shooting Glove	<input type="checkbox"/> RSO on Range	<input type="checkbox"/> _____	<input type="checkbox"/> _____	
<b>Settings:</b>			<b>Results/Groups/Scores:</b>		
Sling: _____	Other: _____	Result #1: _____	Result #6: _____		
Sling Swivel: _____	Other: _____	Result #2: _____	Result #7: _____		
Insert Used: _____	Notes: _____	Result #3: _____	Result #8: _____		
Elevation: _____	_____	Result #4: _____	Result #9: _____		
Windage: _____	_____	Result #5: _____	Result #10: _____		
<b>Goals and Objectives:</b>					
Long Term Goal: _____			<b>SMART GOALS</b>		
_____			Specific		
Medium Term Goal: _____			Measurable		
_____			Achievable		
Training Goal: _____			Realistic		
_____			Timed		
_____			_____		
<b>What I Learned:</b> _____					
_____					
<b>Problems to Solve:</b> _____					
_____					
_____					
<b>Firing Point Sequence:</b>					
<b>Before Firing:</b>			<b>During Firing:</b>		
1. Check equipment - ensure all screws and adjustments are tight, in place, and in working order			1. Check position and repeat as required		
2. Install target safety and correctly			2. Check correct number of shots fired		
3. Correct alignment with the target			<b>After Firing:</b>		
4. Verify Position is legal and correct			1. Perform safety check on rifle		
5. Check aiming and breathing sequence			2. Ensure target and equipment picked up and returned to correct location		
6. Check trigger squeeze and follow-through			3. Diary Entry - Record results		

## ANNEX A

### DEVELOPMENT OF A MARKSMANSHIP TEAM

The development of a marksmanship team should be completed at the beginning of the training year.

- a. **Recruitment of Cadets.** The coach must ensure that the potential cadets are motivated, determined and available. The corps/squadron team must consist of five cadets including a minimum of two (2) juniors. A junior cadet must not have reached their 15<sup>th</sup> birthday on or before the 15<sup>th</sup> of May of the competition year while other cadets cannot have reached their 19<sup>th</sup> birthday by that same date. There is no limit to the number of teams within a local corps/squadron, however, only one team can represent the corps/squadron in the CCM Marksmanship Series Championship. In fact, having more teams will ensure a future pool of interest in the sport.
- b. **Firing on Grouping Targets.** During these competitions, and for the initial selection, coaches must focus their attention on the group size, cadets positions, their mastering of the marksmanship principles as well as their attitude. If cadets are capable of firing an excellent group, they are surely capable of good precision firing. At this stage, coaches should work solely on the basic principles of marksmanship (position, aiming, breathing, trigger control, and follow-through).
- c. **Pre-selection of the Team.** Based on the results of the grouping practice, coaches should choose those cadets who demonstrate the greatest potential. Junior cadets should be identified. Coaches should start a training group to maintain interest for potential members of future teams.
- d. **Precision Firing.** This practice allows coaches to determine the final team composition. Cadets' results count for the final selection. During the training session, coaches must ensure that cadets have the necessary support for a good position.
- e. **Final Selection.** With the help of precision results, coaches must then choose the members of their team. Spare team members should be identified and they should continue to train with the team. Cadets not selected should continue to practice with the training group.
- f. **Selection of a Cadet Coach.** Cadet coaches are appointed based on knowledge, ability and leadership and they are normally the most experienced cadet(s) on the team. They must be capable of zeroing their teammates and of giving them advice. During the competition, they should fire first or last in order to better combine firing and coaching duties. Also, a secondary cadet coach should be trained to perform coaching duties for the main cadet coach.
- g. **Training of Substitutes.** Cadets who are in the training group must not be neglected. They can form an excellent pool of potential team members for the future. This is why it is important to train them so that they can improve their skills and performance. Also, if cadets cannot attend a competition for one reason or another, they can be replaced by a substitute from this pool without any problem.





**ANNEX B**

**AIR RIFLE GROUPING TEMPLATE**

Coaches should switch a marksman to scoring after a 2.0 cm grouping size is achieved.

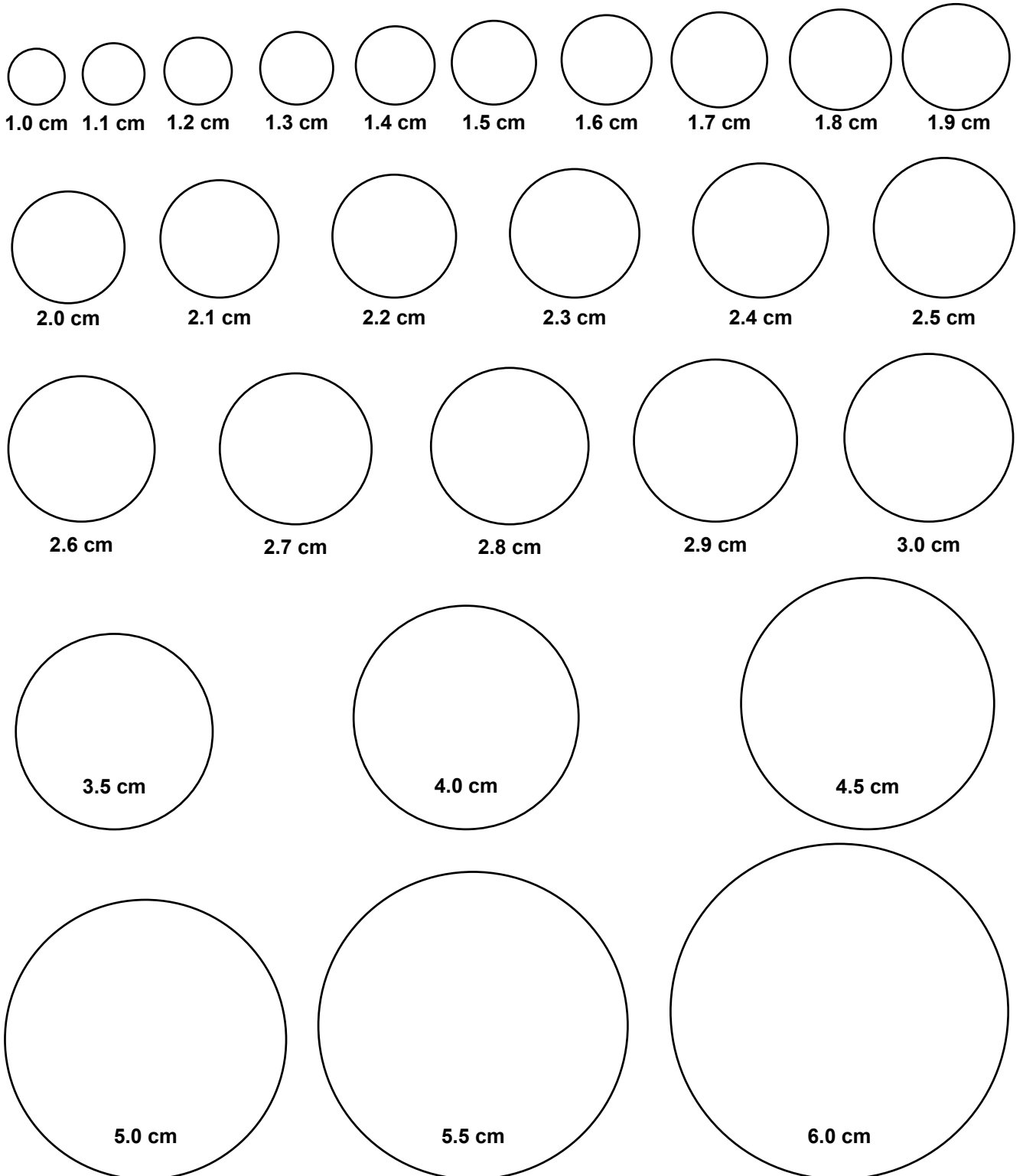



## ANNEX C

### MARKSMANSHIP REFERENCE MATERIAL

The following material provides reference on marksmanship training and coaching. It is available from various sources including National and Provincial/Territorial Shooting Associations, libraries and local bookstores.

#### C.1 CIVILIAN PUBLICATIONS

Cardew, G.V., and Cardew, G.M. *The Airgun From Trigger to Target*. G.V. & G.M. Cardew. 1995. (ISBN 0-9505108-2-3)

Churchill, B., and D. Granville. *Modern Airweapon Shooting*. Newton Abbot: David & Charles. 1981. (ISBN 0-7153-8123-7)

Domey, R. *Mental training for shooting success*. Washington, DC: College Hill Communications. 1988.

Horneber, Ralf. *Olympic Target Rifle Shooting: Technique, tactics and training*. F.C. Mayer Verlag, Munich, Germany. 1993.

International Shooting Union. *General Technical Rules*. 1997.

International Shooting Union. *Special Technical Rules*. 1997.

Krilling, W. *Shooting for Gold*.

Lujan, L. *Shooter's Guide to Position Air Rifle*. United States: Junior Shooting Sports. 1996.

National Rifle Association of America. *Learning to Shoot: A Beginner's Guide to Air Guns*. 1995.

National Coaching Certification Program. *Coaching Theory: Level I, II, And III* (English/French copies available).

Nideffer, R. *Athlete's Guide to Mental Training*. Illinois: Human Kinetics Publishers. 1985. (ISBN 0-931250-96-X).

Orlick, T. *In Pursuit Of Excellence: How to Win in Sport and Life Through Mental Training*. Illinois: Leisure Press. 1990. (ISBN 0-88011-380-4).

Orlick, T. *Psyching for Sport*. Illinois: Leisure Press. 1986. (ISBN 0-88011-273-5).

Owens, J. *Leather Sling and Shooting Positions*. Milwaukee: JAFEICA. 1996.

Owens, J. *Sight Alignment Trigger Control and The Big Lie*. Milwaukee: JAFEICA. 1996.

Pullum, B., and F. Hanenkrat. *The New Position Rifle Shooting*. Peachtree City: Target Sports Education Centre. 1997. (ISBN 0-9655780-0-3).

Pullum, B., and F. Hanenkrat. *Successful Shooting*. Washington, DC: National Rifle Association of America. 1981. (ISBN 0-935998-40-3).

Reinkemeier, H. *On The Training of Shooters: Volumes I and II* (S. Greer, B. Murray, Trans.). National Smallbore Rifle Association. 1992. (ISBN 0-9521077-1-6).

Shooting Federation of Canada National Coaching Certification Program. *Rifle Shooting Technical: Level I and II* (English/French copies available).

Shooting Federation of Canada. *Crosman Airgun Shooting Program Instruction Manual* (English/French copies available).

United States Army Marksmanship Unit. *Junior Marksmanship Rifle Guide*.

Yuryev, A. *Competitive Shooting* (Anderson, Trans.). Washington, DC: National Rifle Association of America. 1985. (ISBN 0-935998-53-5).

## **C.2 MILITARY PUBLICATIONS**

American Legion Junior Shooting Sports Program. *Basic Marksmanship Guide*.

Canadian Forces. *Shoot To Live*.

Canadian Cadet Movement. *Army Cadet National Training Centre Connaught Target Shooting Manual*.

Canadian Cadet Movement *Marksmanship Championship Series Rule Book*.

United States Army Marksmanship Unit, *Marksmanship Instructors' and Coaches' Guide*.

United States Army Marksmanship Guide, *International Rifle Marksmanship Guide*.

## PART 2

---

CANADIAN CADET MOVEMENT

## AIR RIFLE TRAINING AIDE-MÉMOIRE

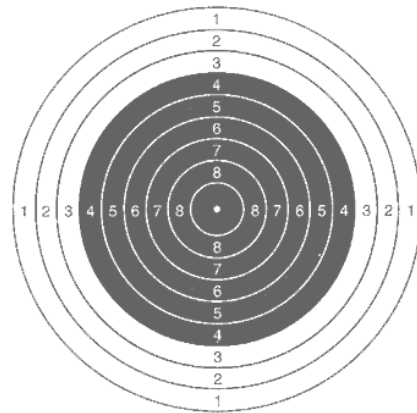
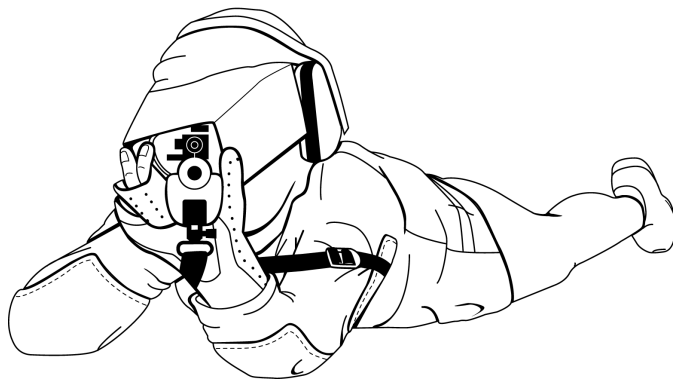



## TABLE OF CONTENTS

	<b>PAGE</b>
<b>PART 1 – AIR RIFLE TRAINING MANUAL .....</b>	<b>1-1-1/1-1-2</b>
<b>PART 2 – AIR RIFLE TRAINING AIDE-MÉMOIRE .....</b>	<b>2-1</b>
General .....	2-1
Safety .....	2-2
Air Rifle Ranges .....	2-4
The Daisy 853C Air Rifle and Pellets .....	2-5
Proper Eye Usage .....	2-6
Prone Position .....	2-7
Standing Position .....	2-9
Kneeling Position .....	2-11
Aiming .....	2-13
Natural Alignment .....	2-14
Breathing .....	2-15
Trigger Control and Follow-through .....	2-16
Use of the Sling .....	2-17
Loading, Firing and Unloading the Air Rifle .....	2-18
Pumping the Air Rifle .....	2-19
Cleaning the Air Rifle .....	2-20
Immediate Action and Stoppages .....	2-21
Range Commands and Procedures .....	2-22
Marksmanship Equipment .....	2-23
Physical Training .....	2-25
Coaching .....	2-26
<b>PART 3 – UNIT MARKSMANSHIP TRAINING PLAN.....</b>	<b>3-1</b>
<b>PART 4 – MARKSMANSHIP CHAMPIONSHIP SERIES .....</b>	<b>4-1-1/4-1-2</b>





**PART 2**

**AIR RIFLE TRAINING AIDE-MÉMOIRE**

**GENERAL**

The purpose of this aide-mémoire is to provide corps, squadrons and Cadet Summer Training Centres with a simple guide to essential marksmanship knowledge and skills. It has been formatted to be easily distributed in the form of handouts. The information found in this document is derived from the Air Rifle Training Manual, which should still be consulted for in-dept reference on any marksmanship subject.

This manual does not take precedence over any Cadet Administrative Training Order (CATO), Canadian Forces Technical Order (CFTO), Canadian Forces Administrative Order (CFAO), or any other Department of National Defence (DND) regulation or order.

When an item refers to a right-handed marksman, the reverse of that item refers to a left-handed marksman.

References to the directions left and right are described from the perspective of a marksman that is in the firing position.

Suggestions for improvements to this document are encouraged and may be submitted to the Staff Officer responsible for marksmanship within each Area/Region.



## SAFETY

*Firearms safety is the number one priority on and off the range so everyone must do their part to prevent accidents. In this sport, the majority of incidents are caused by the ignorance of proper rifle operating procedures or by mishandling.*

### SAFETY CATCH

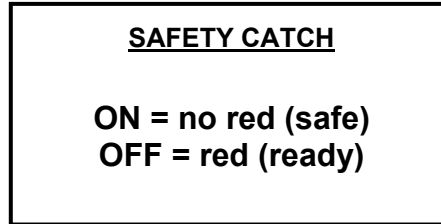

### SAFETY ROD

To ensure that air rifles are not removed from the firing point or stored with a pellet in the chamber or barrel, a safety rod is to be inserted in the barrel from the muzzle end.

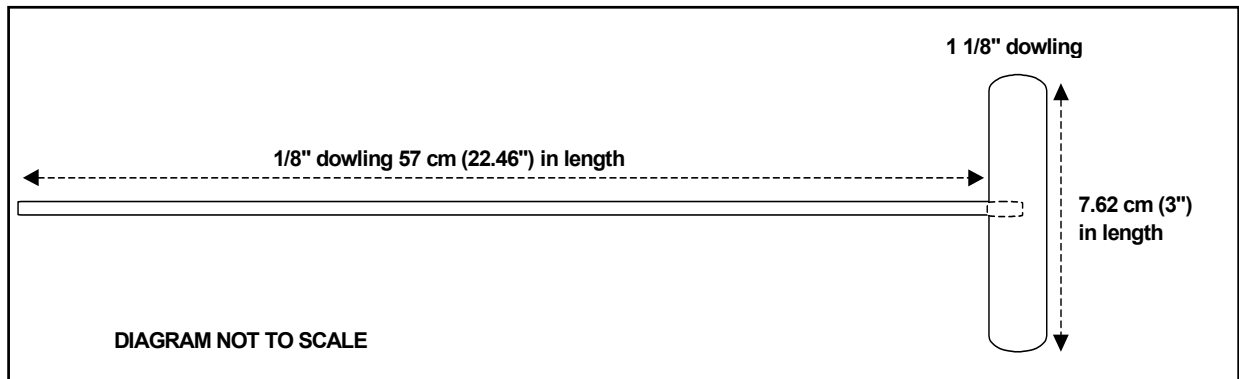

### SAFE RIFLE STATUS

When not being handled on the range or in a training environment, the air rifle must be in a safe status. The following options denote various "safe rifle status".

<p><b>Option One</b> <b>In the rifle case</b></p> <p>Safety catch is ON Bolt is forward Action is not cocked Safety rod is in the case Pump lever is partially open</p>	<p><b>Option Two</b> <b>On the firing line</b></p> <p>Safety catch is ON Bolt is to the rear Pump lever is partially open</p>	<p><b>Option Three</b> <b>Not on the firing line</b></p> <p>Safety catch is ON Bolt is to the rear Safety rod is in barrel Pump lever is partially open</p>
---------------------------------------------------------------------------------------------------------------------------------------------------------------------------------------------	-------------------------------------------------------------------------------------------------------------------------------------------	-----------------------------------------------------------------------------------------------------------------------------------------------------------------------------



## REMOVING A RIFLE FROM THE CASE

The rifle case should be clearly marked on the outside with an arrow, indicating in what direction the rifle inside is pointing. This will ensure that when the case is opened, the rifle is pointing in a safe direction. The rifle must be in a safe status when removed from its case.

## INDIVIDUAL SAFETY PRECAUTIONS

Upon receiving a rifle or when the “safe rifle status” is uncertain, individual safety precautions should be done to confirm that the rifle is safe. An individual must ensure that:

- a. The bolt is open fully to the rear;
- b. The safety catch is in the ON position;
- c. The pump lever is partially open; and
- d. A safety rod is inserted in the barrel.

## SAFETY REGULATIONS

Safety regulations are all common sense and are easy to apply when people understand why they are necessary to help prevent accidents.

The following is a list of essential safety regulations:

- a. A rifle should always be treated as if it is loaded and be considered dangerous unless proven otherwise;
- b. A rifle should never be pointed at anyone;
- c. A rifle should always point in a safe direction;
- d. A rifle should be held in the vertical position with the muzzle pointing up when transporting it;
- e. Fingers should be kept off the trigger unless the marksman is ready to fire;
- f. Hearing protectors may be worn; and
- g. The wearing of safety glasses or shatterproof eyeglasses is mandatory when firing.

## DISPOSAL OF LEAD PELLETS AND PERSONAL HYGIENE

Each time someone handles pellets, a small trace of lead is left on their hands and can be transferred to other parts of their body or to food. Over a period of time, this contact could increase lead levels in the body. It is therefore recommended that hands be washed thoroughly following all contact with pellets.



Spent pellets are regarded as hazardous waste and must be disposed of in accordance with local regulations.



## AIR RIFLE RANGES

***The marksmanship CATO, specifically the annexes on Ranges and Security should be consulted for all the technical details relevant to this subject.***

Air rifles may only be fired on a properly prepared air rifle range. The principal dangers found on an air rifle range are:

- a. The ricochet of pellets after they strike a reflecting surface; and
- b. Improper firearms handling.

It is the responsibility of the RSO to ensure that the range is safe and meets all range requirements. It is essential that no part of the pellet stop area may cause a pellet to ricochet.

### ITEMS REQUIRED TO SET UP AN AIR RIFLE RANGE

- a. Area 15 metres long with controlled access;
- b. Numbered target backstops and firing lanes;
- c. Flags (red and green);
- d. First aid kit and stretcher;
- e. Appropriate mats;
- f. Spotting scopes;
- g. Hearing protectors;
- h. Safety glasses;
- i. Targets;
- j. Pellets; and
- k. Hand washing facility.

### RANGE MAINTENANCE

The range must be cleaned after each use and the lead disposed of as contaminated waste. The pellet stop must be inspected regularly to ensure that deterioration has not occurred.





## THE DAISY 853C AIR RIFLE AND PELLETS

### CHARACTERISTICS

These are the main characteristics and parts of the Daisy 853C air rifle and the pellets used with this rifle:

- a. **Action** – single pump pneumatic, straight pull-bolt;
- b. **Length** – 97.8 cm;
- c. **Weight** – 2.5 kg;
- d. **Calibre** – 0.177" calibre (4.5 mm);
- e. **Front sight** – Global type with interchangeable aperture inserts;
- f. **Rear sight** – Fully adjustable peep rear sight with micrometer click adjustment;
- g. **Muzzle velocity** – 150.8 metres per second;
- h. **Loading** – Single or auto indexing five (5) pellet clip; and
- i. **Stock** – Full-length, sporter-styled hardwood with adjustable length.

### PARTS

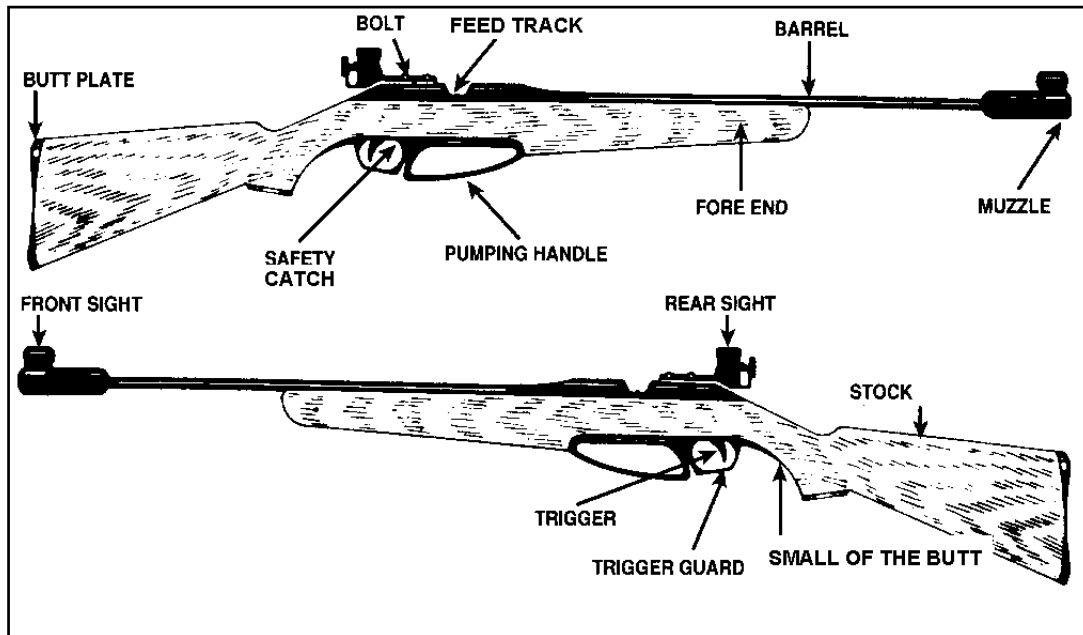

### AIR RIFLE PELLETS

The most popular pellet design is the hourglass-shaped air rifle pellet, commonly referred to as the diabolo. There are a number of variations on the basic diabolo design. For marksmanship and competition training, the wadcutter pellet is used. This flatheaded pellet is designed for cutting neat, clean holes in paper, which allows for accurate, precise scoring of the target.



## PROPER EYE USAGE

***The master eye must be determined before individuals begin firing. It should be noted that the master eye is not always on the same side of the body as the writing hand.***

### SELECTING THE MASTER EYE

Everyone has a master (or dominant) eye which is stronger than the other one. This is the eye to be used when aiming. If the master eye is on the opposite side of the body than the writing hand, it is advisable to change shoulders and fire with the opposite hand and use the master eye. This should not however, be done at the expense of comfort.

### NOTE

If changing shoulders in order to accommodate the master eye proves uncomfortable, cadets should fire the way they feel most comfortable.

To determine the master eye, the steps listed below should be followed:

- a. Select a small object (i.e., the corner of a wall) at least five metres away;
- b. Face the object and extend both arms in front of the body towards the object;
- c. With both eyes open, form a small, tight opening around the object with the thumbs and index fingers;
- d. Look at the object through the opening with both eyes open and draw both hands back toward the face. Ensure that the object remains centred through the opening of the thumbs and index fingers; and
- e. The person should now be looking through the opening at the object with one single eye – the stronger of the two. This is the master eye that should always be used for aiming.

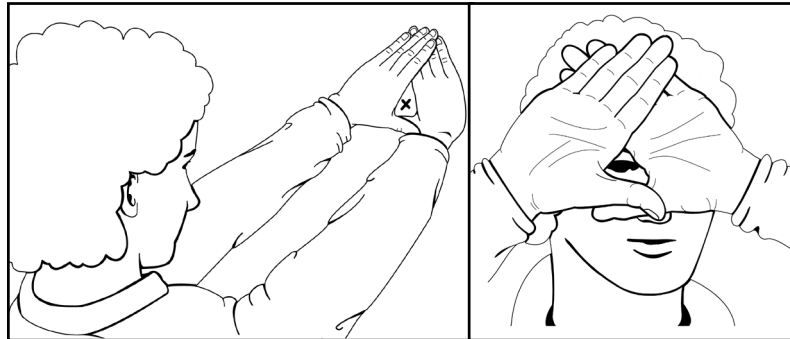

### FIRING WITH BOTH EYES OPEN

Cadets should always fire with both eyes open. Eyes are constantly working together. If cadets have difficulty focusing, the use of a blinder in front of the non-aiming eye will help prevent squinting and eye fatigue.

Cutting a piece of plastic from a windshield washer fluid jug or any other similar type of container can easily make a blinder. A good blinder should be translucent (plastic or paper) so that images are blocked even though light can penetrate it. It should be easily attachable to the rear sight or to the cadet's glasses.



## PRONE POSITION

***Obtaining a good prone position is one of the most, if not the most important principle of marksmanship. Although an excellent position will not guarantee an excellent performance, a poor position can almost assure a substantially negative effect on results.***

### OBJECTIVES OF A GOOD POSITION

The position should be:

- a. Natural;
- b. Without strain;
- c. Comfortable;
- d. Stable;
- e. As such that body weight is equally distributed; and
- f. Consistent throughout the relay.

### CHARACTERISTICS OF A GOOD POSITION

- a. The body should form a 5-20° angle to the line of sight;
- b. The body should not be twisted and the spine should be straight;
- c. The left leg should be parallel with the spine;

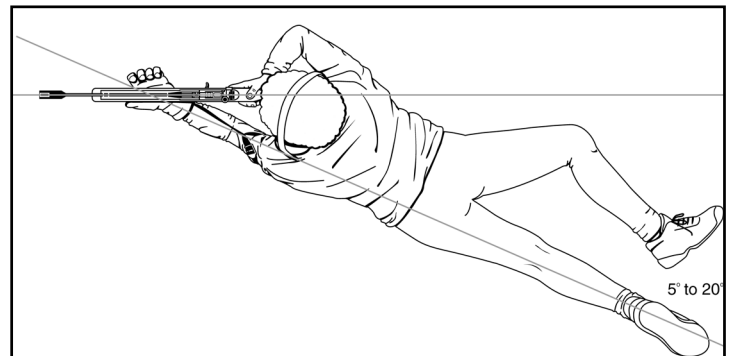

- d. The right foot should turn out and point to the right; the left foot should be straight behind on the toe or pointed to the right according to the comfort of the individual;
- e. The right knee should be brought up so that the thigh forms an angle between 30-45° with the left leg. The right knee should be bent in order to improve stability;

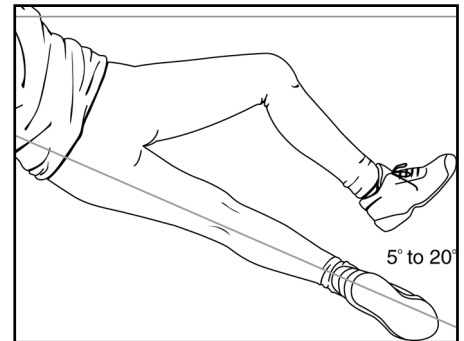



- f. The left elbow should be positioned slightly to the left of the rifle. In order to maintain consistency throughout the relay, the left elbow should not be moved, even while pumping the rifle;
- g. The left forearm should form at least an angle of 30° with the ground;



- h. The left hand should rest in the sling and firmly against the sling swivel and the fingers should not grip the fore end of the stock;

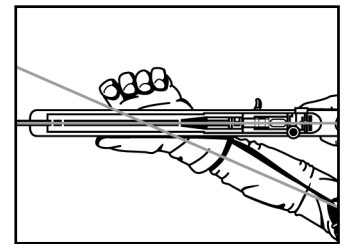

- i. Once a good position is established, the right hand should grip the small of the butt with constant pressure;
- j. The right thumb should be placed on the stock directly behind the rear sight;
- k. The position of the right elbow is established after the rest of the body is in place. After placing the right hand on the small of the butt, the right elbow should rest naturally where it falls and feels comfortable;

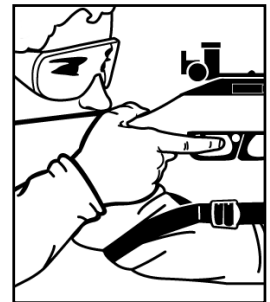

- l. The shoulders should be straight and form right angles with the spine;
- m. The butt plate is kept firmly in the hollow of the right shoulder; and
- n. The head rests comfortably on the butt and remains straight.







## STANDING POSITION

***The standing position has the smallest area of support of all firing positions, thus it is the most difficult to hold steady. Cadets must come to grips with the fact that when firing in the standing position, they may never achieve complete immobility.***

The standing position should be: natural, without strain, comfortable, stable, balanced in such a way that body weight is equally distributed, and consistent throughout the relay.

### CENTRE OF GRAVITY

The centre of gravity is the point where the weight of the rifle and the cadet's body weight are evenly distributed between the feet. In order to compensate for the weight of the rifle, the cadet's back is bent to the right and rearward in order to gain bone support and stability.

If the cadet stands straight, the weight of the rifle will pull the body to the front. Muscle strain will appear in the back as the cadet attempts to keep their body from falling forward. By bending back and to the right, a shift in body weight will occur slightly towards the right foot. At a certain point, the weight of the body on the right foot will equal the weight on the left foot. The body-rifle combination then reaches a state of balance, with the centre of gravity located between the cadet's two feet.

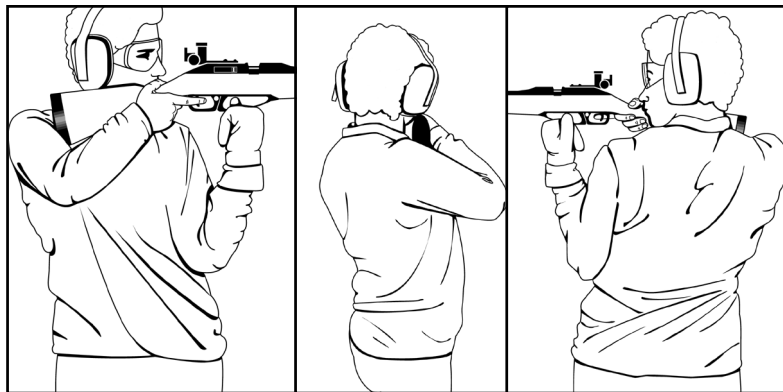
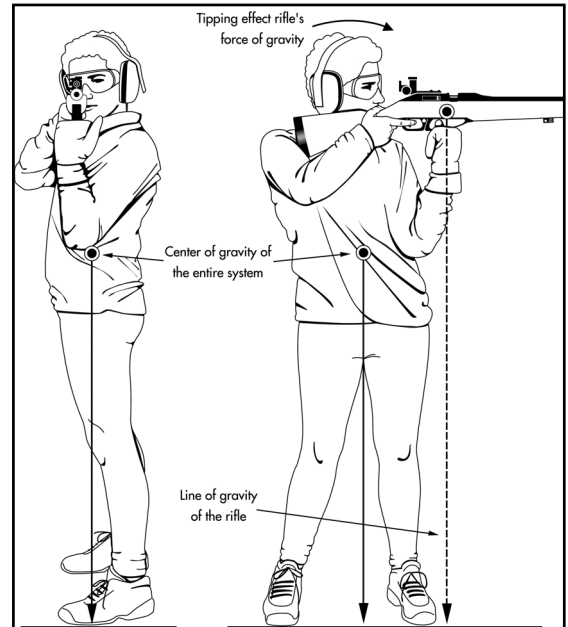

The combination of back bend and body twist is the most important feature of the standing position and will contribute significantly to the cadet's level of performance. However, cadets should understand that discomfort is common during the first few practice sessions. After a short period of time, however, this discomfort will diminish and an increasingly stable hold will be achieved.



**CHARACTERISTICS OF A GOOD POSITION**

- a. The body should face to the right, approximately 90 degrees to the target;
- b. The feet should be shoulder width apart and cadets should try to stand on the firmest surface possible;
- c. The feet should point straight ahead or could be turned slightly outward for comfort;
- d. The legs should be straight but not locked;
- e. The hips should be 90 degrees to the target and should not thrust forward;
- f. The left arm should rest against the rib cage. The left elbow should almost be directly under the rifle. Muscles should not be used to support the left arm;
- g. The left hand is used to support the rifle and should be positioned just forward of the trigger guard. There are several ways of holding the rifle, such as:

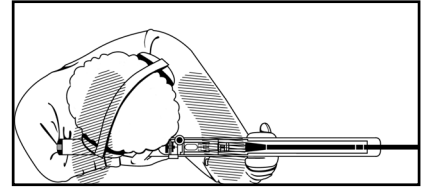
**Clenched fist****V Shape****Split fingers****Heel of the hand**

- h. The right hand should be comfortable and the right arm should drop naturally to the side;
- i. The head should be in an upright position with your eyes looking forward through the rear sight. To prevent involuntary body sway as a result of the balance mechanism in the inner ear, the head should remain straight and upright. The stock should rest high in the shoulder pocket bringing the sights up to eye level to keep from tipping the head forward to aim; and
- j. Eye relief distance should be between 5-15 cm and should usually be slightly greater than in the prone position.

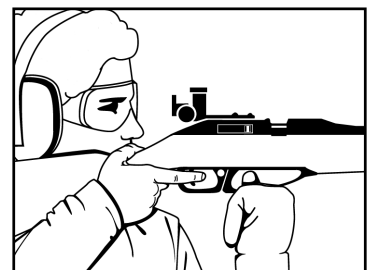



## KNEELING POSITION

***The kneeling position is the least comfortable of all the positions and requires substantial practice in order to master. Once the kneeling position is refined, scores and performances can match those of the prone position.***

The kneeling position is a very stable position similar to the prone position, except achieving a comfortable position which is stable and minimizes movement is more difficult to achieve. The kneeling position is characterized by most firers as the least comfortable position and the most difficult to adopt correctly.

The kneeling position uses a rifle sling and contacts the floor at three points: the kneeling roll and foot combination, the right knee, and the left foot. A correctly adopted kneeling position, combined with practice will result in stability and results similar to the prone position.

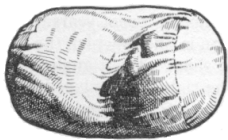

A kneeling roll is a piece of equipment that many firers find improve the stability and comfort of the kneeling position. The main function of the kneeling roll is to provide support under the right foot. The kneeling roll is not always required especially with very flexible cadets.



The kneeling roll can be made from various materials like canvas, cotton, or other flexible materials and filled with material. Materials used to fill the kneeling roll can be dry beans, small plastic beads, wood chips, or other similar materials.

### CHARACTERISTICS OF A GOOD POSITION

- The body should face  $30^\circ$  to  $60^\circ$  to the target, with the left leg pointed in the direction of the target;
- The kneeling roll should be placed at the same angle to the target as the right leg. The kneeling roll should be form fitted to the shooters foot during the preparation stage;
- The left foot and kneeling roll will form a straight line to the target;
- The right knee is placed on the floor at  $30^\circ$  to  $60^\circ$  to the body with the right foot sitting comfortably into the kneeling roll. Approximately 20% of the body weight is supported by the right knee;
- The right heel sits as close to the centre of the buttocks as possible. The right shoe tip sits comfortably on the floor. This combination supports a significant portion of the cadet's weight and this weight is transferred down the spine, into the foot and finally into the kneeling roll. Approximately 40% of the body weight is supported by the kneeling roll and right foot;
- The sling is attached to the rifle and the left elbow sits firmly upon the left knee. The combination of the sling, left elbow and rifle form a load-bearing triangle;

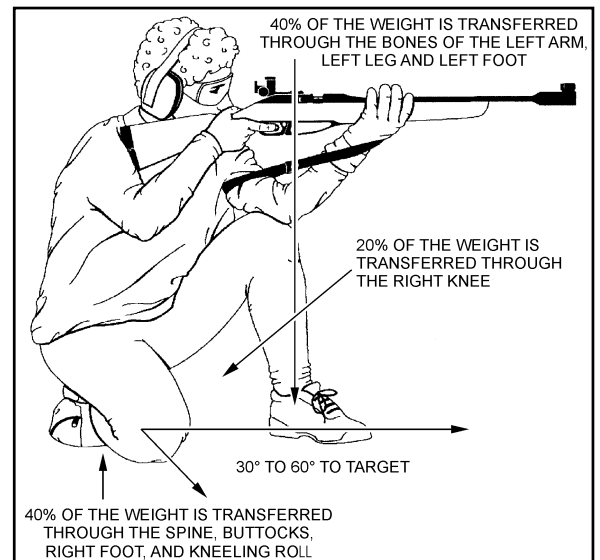



- g. The left hand rests in the sling and firmly against the sling swivel. The fingers of the left hand should not grip the fore-end of the stock. The hand should be relaxed and the rifle should rest in the palm of the hand;
- h. The placement and subtle position changes of the left foot regulate the natural alignment of the position. Altering the location, angle, and position of the left foot, changes in height and right/left direction can be achieved;
- i. The rifle is placed into the right shoulder and the upper body leans against the rifle, which is held into position with the rifle sling;
- j. The left leg from the knee to the floor is at a 70° to 90° angle to the floor. The left foot is turned towards the right side of the body to improve stability of the left leg. Approximately 40% of the body weight is supported by the left leg;
- k. The shoulders should be straight and form right angles with the spine;
- l. The butt plate is kept firmly in the hollow of the right shoulder;
- m. The head rests comfortably on the cheek piece and remains straight and level. The eye relief should be 5 to 15 cm. This distance should remain constant throughout the relay. When the face is placed on the cheek piece, the cadet should be looking directly through the sights; and
- n. The right arm should fall comfortably and naturally to the side of the body and the right hand should be placed upon the small of the butt. The right hand should be comfortable and under no strain. The trigger finger should not touch the stock. The position should allow the right hand, when placed on the small of the butt, to produce a straight back trigger pull.

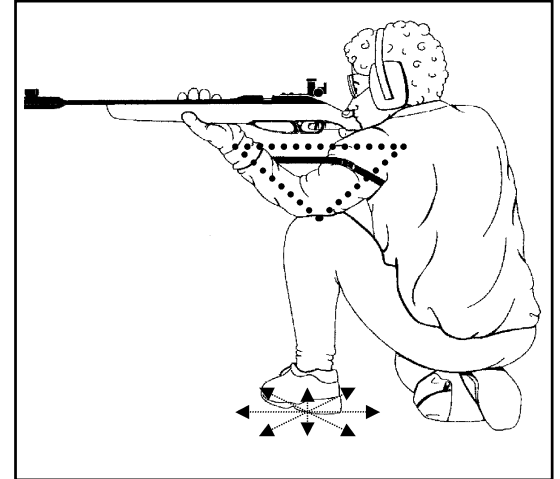

The position and weight distribution of the left leg, right knee, right foot and kneeling roll must remain the same. The head must be levelled and exert the same amount of pressure on the cheek piece, the eye relief must remain constant and the right hand must always be in the same position. If any of these points do not feel right or if the cadet finds the position uncomfortable, the position should be adjusted until the condition is improved.







## AIMING

***Cadets must constantly strive to maintain proper sight alignment, while obtaining a sight picture. It is the most critical element of the aiming process.***

### FRONT SIGHT

The front aperture should be selected to provide the best sight picture. A good sized aperture should appear 1 ½ times bigger than the aiming mark.

### REAR SIGHT

The adjustment of the knobs is measured in clicks that can be felt as the knob is turned. It takes three clicks to move the point of impact approximately one pellet width.

- a. **Elevation.** To lower the point of impact, turn the elevation knob counterclockwise (to the left). To raise the point of impact, turn the elevation knob clockwise (to the right), as per the arrow and the word "UP".
- b. **Windage.** To move the point of impact to the left, turn the windage knob counterclockwise (to the left). To move the point of impact to the right, turn the windage knob clockwise (to the right), as per the arrow and the letter "R".

#### REMEMBER: SIGHT ADJUSTMENT

**UP & RIGHT = clockwise  
DOWN & LEFT = counterclockwise**

### EYE RELIEF

Eye relief is the distance between the eye and the rear sight. Depending on an individual's build and position, this distance is usually 5 to 15 cm. It is important for them to maintain the same eye relief from shot to shot and to find an eye relief that allows them to keep their head as erect as possible during the firing process.

### SIGHT ALIGNMENT

Sight alignment is the most critical element of the aiming process. It is the alignment of the eye, the rear sight, and the front sight.

Proper sight alignment is a matter of centering the front sight hood in the rear sight. The hood will not quite fill the rear sight and cadets will be able to see light around the outside of the hood; we call this a "line of white."

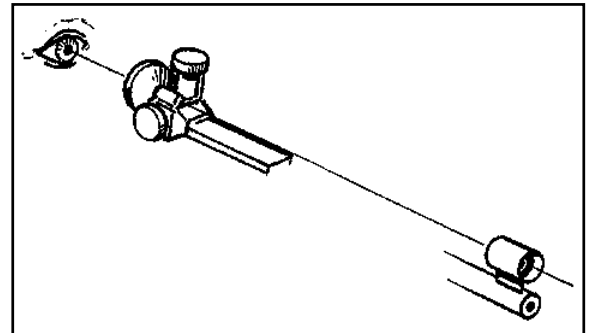

### SIGHT PICTURE

To obtain a proper sight picture, a bullseye is simply added to the innermost ring. The goal during the aiming process is to maintain proper sight alignment while keeping the bull centered in the front sight.

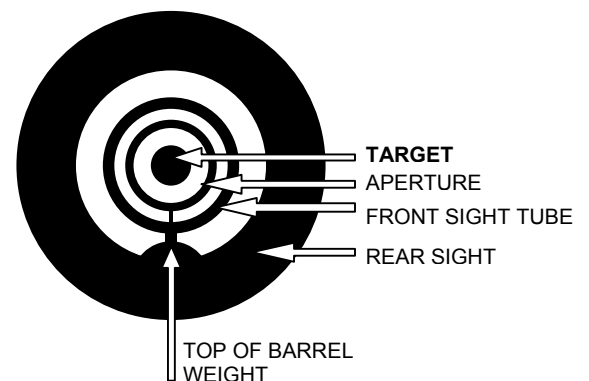



## NATURAL ALIGNMENT

***It is essential that cadets use their bones to support the rifle, so that their muscles remain relaxed. Under no circumstances should they use their muscles to change the point of aim by moving the rifle from side to side.***

Natural alignment is obtained when the rifle can be perfectly aimed at the target without being muscled into achieving this. In a comfortable position, the cadet does not force the air rifle to point to the target, which would create muscular tension.

After establishing a comfortable position, the cadet must now make sure that their body and rifle are directly aligned with the target. In order to ensure that the position is directly in line with the target, cadets should follow these steps:

- a. Assume the prone position, look through the sights and acquire a proper sight picture;
- b. Close their eyes, take several normal breaths and relax into a comfortable position;
- c. Once comfortable, look through the sights again. If they are perfectly centred with the target, proceed with firing;
- d. If they are not directly centred with the target, they will need to re-orient their position slightly. To do this, they will need to pivot their body on their left elbow, more precisely:
  - (1) If they are aiming too far to the left, move the lower body slightly to the left;
  - (2) If they are aiming too far to the right, move the lower body slightly to the right;
  - (3) If they are aiming too low, move the lower body slightly back (if this does not work, they can tighten the sling); and
  - (4) If they are aiming too high, move the lower body slightly forward (if this does not work, they can loosen the sling); and
- e. Close their eyes and do a final check on their alignment. If they are still not perfectly aligned, they must start over! They must remember to never move their left elbow when they shift their position around.



## BREATHING

***Cadets should use breathing as a way to confirm that the rifle is moving up and down in a perfect vertical manner and that the rifle is not canted. Also, when breathing in and out, cadets can visually confirm that they are aiming on the proper diagram.***

### IMPORTANCE OF BREATHING

While breathing, the oxygen inhaled is used to supply muscles with energy, ensuring optimal potential of these muscles. This includes the muscles that are involved in the position, as well as the muscles in the eyes. For maximum stability when firing, cadets will have to stop breathing for a few seconds. It is of the utmost importance that they do not hold their breath for more than five to seven seconds, as the tension will increase in their chest muscles and reduce stability.

### THE BREATHING CYCLE

In order to achieve a proper breathing sequence, the information in the following graph should be adhered to:

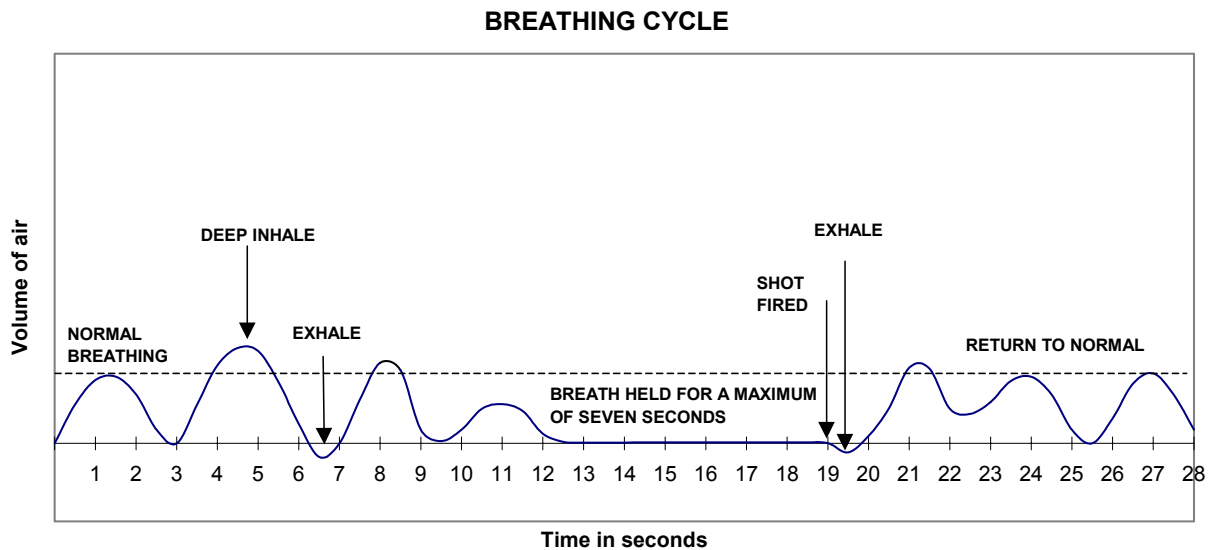

Again, it is important for cadets not to fire if they feel they want to breathe again. Their shot will not be perfect and their end result will be affected.



## TRIGGER CONTROL AND FOLLOW-THROUGH

*Trigger control is the manipulation of the trigger in such a way that there is no disturbance or motion of the foresight. It must be constant, controlled, slow and deliberate. Consistent squeezing of the trigger assures the desired trajectory upon the departure of the pellet.*

### POSITION OF THE HAND ON THE RIFLE

Cadets should have a relatively firm grip on the small of the butt with the bottom three fingers of their hand. The thumb should point forward and rest in a relaxed position behind the rear sight along the rifle stock or should be wrapped around the small of the butt.

### TRIGGER FINGER POSITION

The index finger should be placed on the trigger halfway between the tip of the finger and the first joint. The index finger never touches the stock of the rifle and must be vertically centered on the trigger.

### SQUEEZING THE TRIGGER

Trigger pressure should only be applied when the cadet is ready to fire. It must be applied straight to the rear by bending the second joint of the index finger. Cadets should make sure the pressure they apply is constant and that they slowly squeeze the trigger while they are holding their breath.

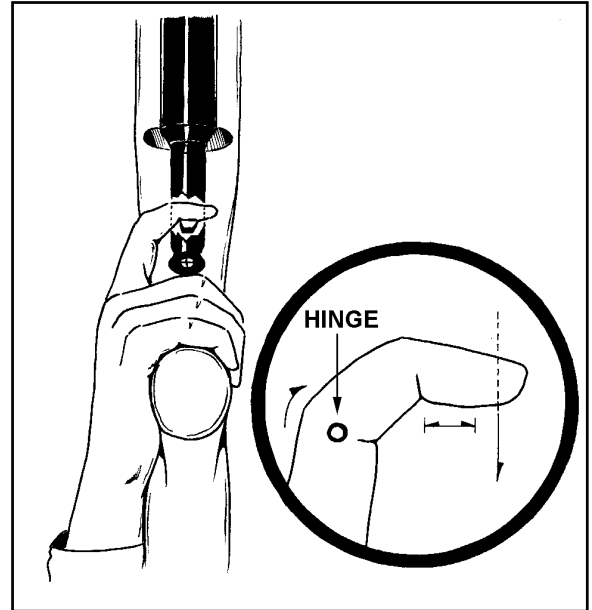

### FOLLOW-THROUGH

Follow-through is defined as the act of remaining in position for a few seconds after the pellet's departure and it requires both physical and mental effort. It aids in developing proper hold of the rifle, maintaining stability, ensuring that there is no movement of the rifle as the shot is being fired, and calling the shot after it is fired.

When done properly, it permits the cadet to call their shot with extreme accuracy and ensures consistency during the firing session. This becomes particularly important when trying to improve performance or correct faults. If the position is stable, the aiming picture should return to the same place it was before the vibrations caused by the release of compressed air.





## USE OF THE SLING

*The sling provides maximum support of the rifle with the least amount of physical effort on the part of the individual.*

### ASSEMBLING THE SLING

To assemble the sling, follow the steps listed below:

- a. Hold the sling parallel to the ground with the short section in the left hand, ensuring that the rounded tip of the top buckle is pointing left;
- b. Take the short section, loop it up through the middle slot of the metallic clasp and then back down through the front slot (nearest the rounded tip). The short section will now form a circle; and
- c. Turn the sling over and slide the sling swivel onto the long section. Ensure the sling swivel hangs downwards, as it will later attach to the rifle. Loop the long section up through the middle slot and then back down through the front slot. It is now important to take the remaining end and loop it back through the rear slot, locking the sling in place. This will ensure that the sling will not come undone or loosen during firing.

### POSITION OF THE SLING ON THE ARM

The sling should be positioned on the upper left arm above the biceps near the shoulder. This is the area on the arm where the smallest amount of pulse can be felt. The sling should never be twisted.

### ATTACHMENT OF THE SLING TO THE RIFLE

The sling should be attached to the rifle using its hook. To attach the sling, the hook on the sling should be opened by pressing on its side screw. The hook pin should be slipped into the attachment clamp on the rifle's sling swivel and the hook should be screwed over the pin to ensure it will not fall out.

### ADJUSTMENT OF THE SLING

If the sling is too loose it will no longer act as a method of support and the cadet will hold the rifle using their muscles. If the sling is too tight, blood flow will be restricted and cause a more pronounced pulse, which will have a negative effect on the cadet's hold.



## **LOADING, FIRING AND UNLOADING THE AIR RIFLE**

*These steps should be adhered to in order to safely fire the Daisy 853C air rifle.*

### **LOADING THE AIR RIFLE**

The following steps should be followed when loading the rifle:

- a. Pick up and hold the rifle with the left hand;
- b. Ensure the safety catch is in the ON position;
- c. Place the sling on the rifle;
- d. Pump the rifle;
- e. When the pump handle is fully extended, pause for about three seconds;
- f. Bring the pump lever back to the closed position;
- g. Load a pellet or a five (5) pellet clip; and
- h. Close the bolt.

### **FIRING THE AIR RIFLE**

The following actions should be performed in order to fire the rifle:

- a. Place the safety catch in the OFF position;
- b. Aim the rifle at the target;
- c. Squeeze the trigger;
- d. Open the bolt, pump the rifle, reload, aim and fire;
- e. Repeat the last step until the firing is done;
- f. Upon completion, open the bolt, place the safety catch in the ON position and partially open the pump lever; and
- g. Lay the rifle down.

### **UNLOADING THE AIR RIFLE AND PREPARING FOR INSPECTION**

These steps should be followed when unloading the rifle:

- a. Pick up the rifle;
- b. Remove the five (5) pellet clip (if used);
- c. Pump the rifle;
- d. Move the bolt forward (do not insert a pellet);
- e. Place the safety catch in the OFF position;
- f. Aim the rifle at the target;
- g. Squeeze the trigger;
- h. Open the bolt;
- i. Place the safety catch in the ON position;
- j. Open the pump lever slightly;
- k. Place the rifle on the shoulder, muzzle pointed down range;
- l. Wait to be cleared by the RSO; and
- m. Lay the rifle down.



## PUMPING THE AIR RIFLE

*Even though this method may seem quite awkward, any cadet can easily perform it.*

To pump the rifle, the cadet should follow these steps:

- a. Remove the butt from the shoulder and rest it on the mat;
- b. Partially open the pump lever with the right hand;
- c. Return the right hand to the small of the butt;
- d. Grasp the pump lever with the left hand, halfway up the lever;
- e. Lift the rifle upwards until the pump lever is fully extended (keep the left elbow on the mat);
- f. Pause for three seconds when the pump lever is fully extended;
- g. Bring the rifle down, thereby returning the pump lever to the closed position;
- h. Load the pellet or the five (5) pellet clip; and
- i. Move the bolt forward.

### Prone Position

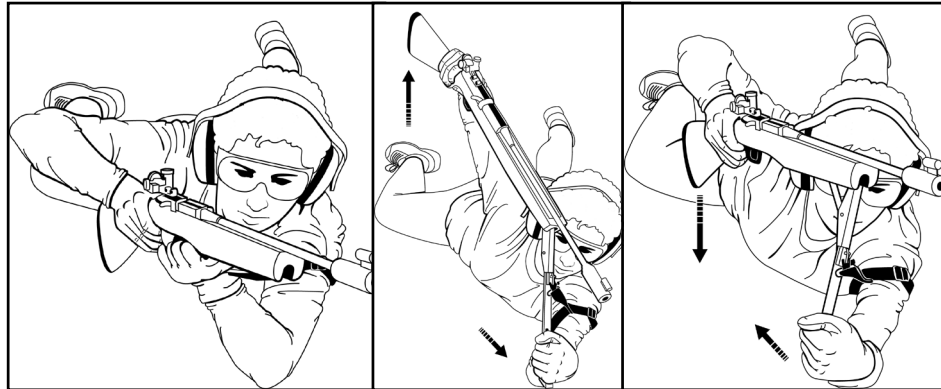

### Kneeling Position





## CLEANING THE AIR RIFLE

*No one should attempt to clean a rifle until individual safety precautions have been performed on the rifle and it is certain that the barrel is clear of any obstructions.*

### CLEANING THE BORE

When	Action
Before firing	Fire 2-3 felt cleaning pellets.
After firing	Fire 2-3 felt cleaning pellets.
Periodic	Fire a felt cleaning pellet soaked in SAE 30 motor oil; Wait 5 minutes; and Fire 3 felt cleaning pellets.
Storage of three months or longer	Fire 2-3 felt cleaning pellets; Fire one felt cleaning pellet soaked in SAE 30 motor oil; and Fire 3 felt cleaning pellets when taking rifle out of storage.

### CLEANING OF OTHER PARTS

- a. **Stock.** The stock should be frequently wiped clean with a damp cloth;
- b. **Metallic Parts.** The exterior metallic parts of the rifle should be cleaned on a regular basis with the aid of a lightly oiled flannel patch; and
- c. **Pivot Points.** The pivot points should also be lightly lubricated on a regular basis.





## IMMEDIATE ACTION AND STOPPAGES

*When a problem occurs, the cadet must point the rifle down range at all times and notify the RSO.*

PROBLEM	SOLUTION
Pellet incorrectly seated in chamber	Place the safety catch in the ON position; Open the bolt fully to the rear; and RSO will insert a safety rod in the barrel to clear the pellet.
Pellet stuck in barrel	Place the safety catch in the ON position; Open the bolt fully to the rear; and RSO will insert a safety rod in the barrel to clear the pellet.
Two pellets lodged in the barrel or chamber	Attempt twice to fire the pellets out. If unsuccessful: <ol style="list-style-type: none"> <li>a. Place the safety catch in the ON position;</li> <li>b. Open the bolt fully to the rear; and</li> <li>c. RSO will insert a safety rod in the barrel to clear the pellet.</li> </ol>
Rifle does not fire	Conduct a functioning test: <ol style="list-style-type: none"> <li>a. Place the safety catch in the ON position;</li> <li>b. Open the bolt fully to the rear;</li> <li>c. Close the bolt;</li> <li>d. Place the safety catch in the OFF position; and</li> <li>e. Squeeze the trigger.</li> </ol> <p>If the rifle still does not fire, conduct a pumping functioning test:</p> <ol style="list-style-type: none"> <li>a. Place the safety catch in the ON position;</li> <li>b. Open the bolt fully to the rear;</li> <li>c. Pump the rifle;</li> <li>d. Close the bolt;</li> <li>e. Place the safety catch in the OFF position; and</li> <li>f. Squeeze the trigger.</li> </ol> <p>If the rifle still does not fire, clear the rifle:</p> <ol style="list-style-type: none"> <li>a. Place the safety catch in the ON position;</li> <li>b. Open the bolt fully to the rear and partially open the pump lever; and</li> <li>c. RSO will insert a safety rod in the barrel to clear the pellet.</li> </ol>



## RANGE COMMANDS AND PROCEDURES

*The following range commands will be given by the RSO and must be learned by cadets before they fire on a range.*

COMMAND	ACTION
Cover off your firing point	Stand up, move behind the firing point and await further commands.
Place your equipment down and stand back	Lay the equipment down on the mat and stand back when finished.
Adopt the prone position	Adopt the prone position, pick up the rifle, ready the equipment and put on the hearing and eye protection.
Type of firing	This command includes information about the range and type of firing. i.e., Relay No. __, 10 metres, five rounds, Grouping, On Your Own Time...
Relay, load, commence firing	Ensure the safety catch is in the ON position; Pump the rifle; When the pump lever is fully extended, pause for about three seconds; Load the pellet; Close the bolt; Place the safety catch in the OFF position; Aim the rifle at the target; Squeeze the trigger; Open the bolt; Repeat the sequence for each shot; Place the safety catch in the ON position and partially open the pump; lever immediately after firing the practice; and Lay down the rifle.
MAY BE GIVEN	
Relay, cease fire	Stop firing, put the safety catch in the ON position and lay the rifle down.
Relay, resume fire	Put the safety in the OFF position and continue the practice.
Relay, unload and prepare for inspection	Pick up the rifle; Remove the five (5) pellet clip if used; Pump the rifle; Close the bolt; Place the safety catch in the OFF position; Aim rifle at target; Pull the trigger; Open the bolt; Place safety catch in the ON position; Open the pump lever 5-8 cm; Place the rifle on the shoulder, muzzle pointed down range; Wait to be cleared by the RSO; Lay the rifle down; and Remove hearing and eye protection.
Relay, stand up	Stand up and leave the equipment on the ground.
Change targets	Move forward, walk down the lane to remove old targets and replace them with new ones. Return to the firing point.
Change relays	Cadets who have just fired pick up their personal equipment and move of the firing point. The new relay covers off behind the firing point.



## MARKSMANSHIP EQUIPMENT

*Cadets performance can be easily improved by providing them with adequate apparel. This apparel will help to increase both stability and comfort.*

### MARKSMANSHIP JACKET

A jacket offers some support and helps stabilize the body. Rubber pads are attached to the elbows and to the right shoulder to soften contact with the ground and with the rifle. The jacket must be large enough to permit the wearing of sweaters.

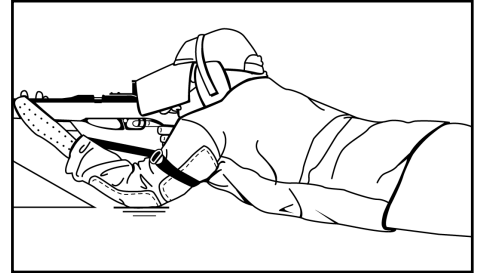

### MARKSMANSHIP GLOVE

The marksman's glove protects the back or interior of the hand against pressures created by the sling and the sling swivel.

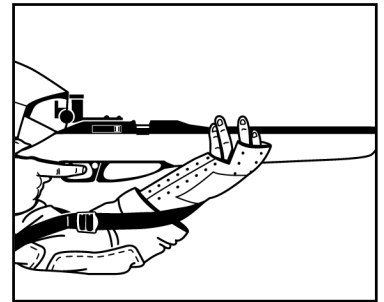

### MARKSMANSHIP HAT

The marksman's hat has flap sides and an elongated peak, which creates a tunnel vision and helps in avoiding neighbouring distractions.

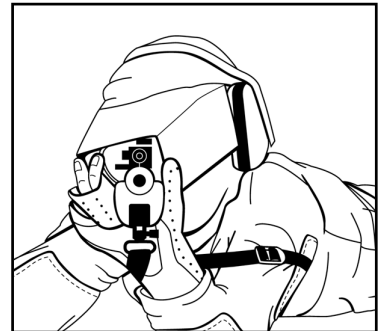

### SWEATERS

It is of the utmost importance to wear at least one sweater under the marksman's jacket. If possible, two sweaters should be worn. These sweaters increase stability and absorb pulse beat.

### TELESCOPE

Telescopes are used so that the cadet or coach can view the target and make sight adjustments based on the fired shots.

### MATS

Mats or ground sheets are used to aid the comfort of the cadets. However, they may not be used to provide an artificial support.



**TABLE, CHAIRS OR ADJUSTABLE DEVICE**

Tables, chairs or adjustable devices are used in the standing and kneeling positions. These aids are used to ensure all equipment (scope, tools, inserts, etc.), pellets and targets are close enough to the cadet so the position is not affected when requiring these items during a course of fire. The table, chair or adjustable device must not act as an artificial support for the cadet.

**KNEELING ROLL**

A kneeling roll is placed under the right foot in the kneeling position. The kneeling roll is an optional piece of equipment and some cadets may find it improves comfort and stability in the kneeling position.





## PHYSICAL TRAINING

*Physical training improves and develops the strength and endurance required to hold the rifle steady for long periods of time without fatigue.*

### WARM-UP EXERCISES TO BE DONE BEFORE STATIC STRETCHING

Each exercise should last about 20-30 seconds and it is important not to bounce or jerk when doing them.



Neck

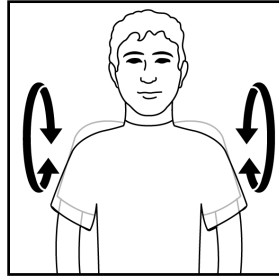

Shoulders

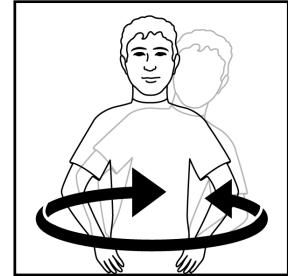

Trunk

### STATIC STRETCHING EXERCISES

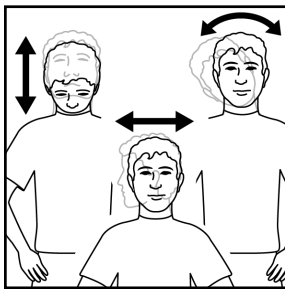

Head and neck



Shoulders, arms and wrists

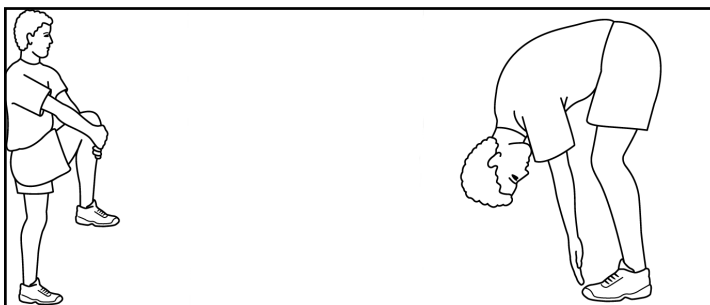
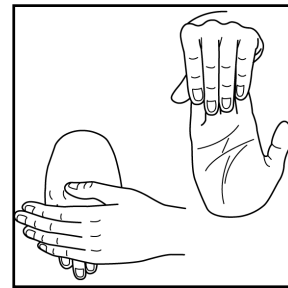

Back

***Before a competition or practice, a warm-up exercise is recommended in order to get the blood flowing and the muscles tuned.***

***Stretching exercises can help the individual's flexibility and level of comfort during the firing session.***



## COACHING

### DUTIES OF A COACH

The role of a coach is to aid, assist, teach and help improve a cadet's performance. A good coach is able to recognise and improve imperfections in position, holding and firing. The following are tasks commonly performed by coaches:

- a. Providing positive reinforcement;
- b. Instilling self-confidence;
- c. Correcting marksmanship principles and techniques;
- d. Correcting position problems;
- e. Maintaining a coaching diary; and
- f. Analyzing targets.

### ANALYSIS OF COMMON ERRORS

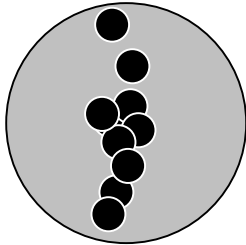

Improper position of the buttplate  
Variance in breathing  
Variance in eye relief

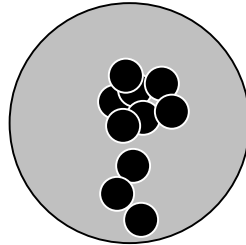

Sling slipping  
Left hand moving forward

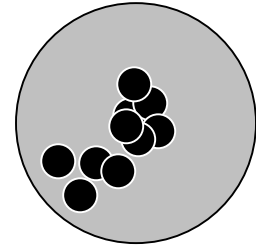

Anticipation of recoil

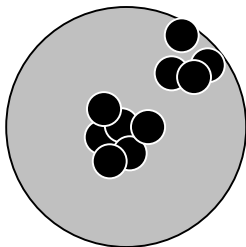

Anticipation of recoil

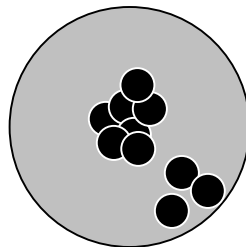

Jerking the trigger

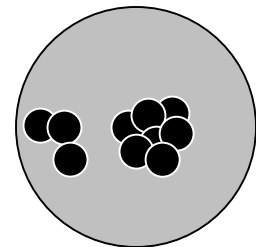

Squeezing the trigger at an angle  
Improper usage of the sling

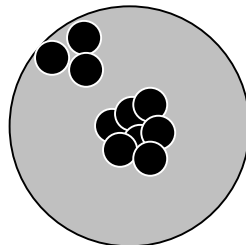

No follow-through or anticipation



## **PART 3**

---

**CANADIAN CADET MOVEMENT**

**UNIT MARKSMANSHIP TRAINING PLAN**



## TABLE OF CONTENTS

	PAGE
<b>PART 1 – AIR RIFLE TRAINING MANUAL .....</b>	<b>1-1-1/1-1-2</b>
<b>PART 2 – AIR RIFLE TRAINING AIDE-MÉMOIRE .....</b>	<b>2-1</b>
<b>PART 3 – UNIT MARKSMANSHIP TRAINING PLAN.....</b>	<b>3-1</b>
Introduction .....	3-1
Unit Marksmanship Team – Yearly Training Plan Overview .....	3-2
<b>General Preparation Phase (6 Weeks – 01 Oct – 15 Nov) .....</b>	<b>3-4</b>
Week 1 – First Team Selection .....	3-4
Week 2 – Application of Marksmanship Principles I .....	3-5
Week 3 – Application of Marksmanship Principles II .....	3-6
Week 4 – Application of Marksmanship Principles III .....	3-7
Week 5 – Application of Marksmanship Principles IV .....	3-8
Week 6 – The Sling and Marksmanship Equipment.....	3-9
<b>Specific Preparation Phase (6 Weeks – 15 Nov – 22 Dec) .....</b>	<b>3-10</b>
Week 7 – Relaxation Techniques .....	3-10
Week 8 – Development of a Shot Routine I.....	3-11
Week 9 – Development of a Shot Routine II.....	3-12
Week 10 – Endurance Training I .....	3-13
Week 11 – Mental Training .....	3-14
Week 12 – Break .....	3-16
<b>Pre-competition Phase (7 Weeks – 22 Dec – 15 Feb).....</b>	<b>3-17</b>
Week 13 – Match Routine I.....	3-17
Week 14 – Match Routine II.....	3-18
Week 15 – Endurance Training II .....	3-19
Week 16 – Rhythm Training .....	3-20
Week 17 – Endurance Training III .....	3-21
Week 18 – Competition Simulation I.....	3-22
Week 19 – Competition Simulation II.....	3-23
<b>Competition Phase (6 to 8 Weeks – 15 Feb – 15 April) .....</b>	<b>3-24</b>
Week 20 – Development of Tactics .....	3-24
Week 21 – Competition Simulation III.....	3-25
Week 22 – Endurance Training IV .....	3-26
Week 23 – Competition Simulation IV .....	3-27
Week 24 – Zone Championship.....	3-28
Week 25 – Development of a Shot Routine III.....	3-29
Week 26 – Competition Simulation V .....	3-30
Week 27 – Provincial Championship .....	3-31
<b>PART 4 – MARKSMANSHIP CHAMPIONSHIP SERIES .....</b>	<b>4-1-1/4-1-2</b>





## **PART 3**

### **UNIT MARKSMANSHIP TRAINING PLAN**

#### **INTRODUCTION**

Since the introduction of the CCM's Marksmanship Championship Series in 1998, over 700 corps and squadrons have actively participated in Zone or Mail-In competitions. Many of those corps/squadrons have also developed marksmanship teams that train on a weekly basis. In order to facilitate the training of new units and improve the level of marksmanship teams that are currently active, the CCM has produced a yearly training plan broken down in 27 weekly training sessions.

This training plan has been developed to meet the following goals:

- a. Give the corps/squadron coach a guide to better run weekly training sessions;
- b. Provide a structured plan to encompass the various technical components of marksmanship training; and
- c. Develop dynamic training sessions to improve the cadets' proficiency level in marksmanship;

This training plan is based on a corps/squadron that trains once a week from October until the Provincial/Territorial Championship. The number of weeks allocated to training may vary depending on the timing of the various championships.

This training plan should only be used as a guide and can be modified to better fit the corps/squadron's training schedule.



## UNIT MARKSMANSHIP TEAM – YEARLY TRAINING PLAN OVERVIEW

WEEK	ACTIVITY	SHOTS FIRED
<b>GENERAL PREPARATION PHASE (6 WEEKS)</b>		
1	<b>Initial team selection</b>	8 groups of 5 shots <b>or</b> 2 relays of 2 targets (40 shots on score)
2	<b>Application of marksmanship principles I</b> Goal setting Selection of master eye Prone position	6 groups of 5 shots
3	<b>Application of marksmanship principles II</b> Stretching Natural alignment Breathing	8 groups of 5 shots
4	<b>Application of marksmanship principles III</b> Training diary Aiming	12 groups of 5 shots
5	<b>Application of marksmanship principles IV</b> Trigger control Follow through Use of marksmanship equipment Sling	12 groups of 5 shots
6	<b>Marksmanship equipment</b>	10 groups of 5 shots
<b>SPECIFIC PREPARATION PHASE (6 WEEKS)</b>		
7	<b>Relaxation</b> Progressive Muscle Relaxation Breathing Relaxation Refinement of position	12 groups of 5 shots
8	<b>Developing a shot routine I</b> Natural alignment Shot routine	12 groups of 5 shots
9	<b>Developing a shot routine II</b> Aiming, Breathing, Trigger control, Follow-through Breaking the shot sequence	14 groups of 5 shots
10	<b>Endurance training I</b> Physical training	3 relays of 8 groups of 5 shots (120 shots)
11	<b>Mental training</b> Concentration Perception	6 groups of 5 shots and exercise (24 shots)
12	<b>Break</b>	



<b>PRE-COMPETITION PHASE (7 WEEKS)</b>		
13	<b>Match routine I</b> Sight adjustments Match routine	2 relay of 2 targets (40 shots on score)
14	<b>Match routine II</b> Natural alignment Match routine	Natural alignment exercises (40 shots)  1-2 relays of 2 targets (20-40 shots on score)
15	<b>Endurance training II</b>	3 relays of 3 targets (90 shots on score)
16	<b>Rhythm training</b>	Exercises 2 relays of 2 targets (40 shots on score)
17	<b>Endurance training III</b>	3 relays of 3 targets (90 shots on score)
18	<b>Competition simulation I</b> Exercises	Exercises (Approximately 40 shots) 2 relays of 2 targets (40 shots on score)
19	<b>Competition simulation II</b> Exercises Final team selection	Exercises (Approximately 40 shots) 2 relays of 2 targets (40 shots on score)
<b>COMPETITION PHASE (8 WEEKS)</b>		
20	<b>Development of tactics</b>	2 relays of 2 targets (40 shots on score)
21	<b>Competition simulation III</b> Exercises	4 relays of 2 targets (80 shots on score)
22	<b>Endurance training IV</b>	3 relays of 3 targets (90 shots on score)
23	<b>Competition simulation IV</b> Positive thinking	2 relays of 2 targets (40 shots on score)
24	<b>Zone championship</b>	15 practice shots 40 competition shots on score
25	<b>Developing a shot routine III</b> Competition debrief Shot routine	10 groups of 5 shots
26	<b>Competition simulation V</b> Positive thinking	2 relays of 2 targets (40 shots on score)
27	<b>Provincial championship</b>	15 practice shots 40 competition shots on score



## **GENERAL PREPARATION PHASE (6 WEEKS – 01 OCT – 15 NOV)**

### **WEEK 1 – FIRST TEAM SELECTION**

The following is the selection criteria for the first team:

- Aim – Select a minimum of six cadets (up to a maximum of eight), including at least three juniors
- Selection must be open to all cadets
- Selection to be done either on group size or score
- Criteria must be set in advanced, known by all and respected
- Cadets may use marksmanship apparel as stated in the CCMACS Rule Book

The selection is done early in order to start to train the team as soon as possible. Focussing on more than eight cadets would prove very difficult for the coach and the firing time would be reduced for all team members.

It is crucial to keep at least one or two spares to replace cadets who may have to drop off the team. Furthermore, a sense of competitiveness is good to motivate the cadets. After the selection is done, focus the training only on team members. A second team can be set up to build a pool of talented cadets but this should not be done to the detriment of the main team.

It is recommended that the initial selection be done using only the sling and no other marksmanship equipment. This will point out the cadets with “natural talent”. Also, it is recommended that cadets fire on grouping targets and not scoring targets as this will allow cadets of all levels an equal opportunity to qualify for the team.





## WEEK 2 – APPLICATION OF MARKSMANSHIP PRINCIPLES I

### Goal setting

- Define goal setting
- Explain how goal setting will play a role in each training session

### Selection of the master eye

- Importance of the master eye
- Cadets find their master eye

### Prone Position

- The prone position (theory)
- The prone position (demonstration – have a model)
- Various characteristics of the position and the reasoning behind these characteristics
- Steps to adopt the prone position using a rest
- Benefits of using a rest
- Cadets adopt the position using a rifle rest and get a feel for the position
- Correct the positions
- Cadets fire groups using a rest while emphasising the feel of the position (six groups of five shots)

The coach prior to **each** training session should identify goals. This allows the cadets and the coach to focus on the task at hand. The goals can be different for all cadets as their levels of abilities may vary greatly. Cadets and coaches must not lose sight of previous goals and must build on the attained ones. When setting goals, the coach should ensure that they are SMART: **S**pecific, **M**easurable, **A**ttainable, **R**ealistic and **T**imely. An example of a training goal could be for a cadet to fire eight perfect shots out of ten on a given target (Perfect shots do not necessarily have to be 10s!)

It is crucial to have the cadets select their master eye before they start learning about the other concepts.

When teaching the prone position, it is very important that cadets understand why all the different characteristics are important. If they do understand the reasoning behind these characteristics, it will be much easier for them to apply them. When correcting the positions, remember that all cadets are different, therefore they will all have slightly different positions. However, it is important to not deviate too far from the norm. It is crucial for the cadets to develop a feel for their positions. They are the only ones that know if they are adopting the same position shot after shot, and the only way for them to know is through feel. This will take a long time to master but they have to start the process right away.



## WEEK 3 – APPLICATION OF MARKSMANSHIP PRINCIPLES II

### Stretching

- Importance of stretching
- Describe stretching exercises
- Cadets do stretching exercises

### Natural Alignment

- The concept of natural alignment
- Demonstrate how to perform natural alignment
- Natural alignment exercises on the rifle rest
- Cadets fire groups using a rest while emphasizing natural alignment (four groups of five shots)

### Breathing

- The importance of breathing in marksmanship
- Breathing exercises using a rifle rest
- Cadets fire groups using a rest while emphasizing the breathing sequence (four groups of five shots)

Stretching exercises should be done before **every** practice. This greatly minimizes the time necessary for the position to settle. Although it's not mentioned later on, incorporate 5-10 minutes of stretching exercises at the beginning and end of **each** session.

When firing on 12 diagram targets, natural alignment is of the utmost importance. It is therefore important to start working on it now.

### Natural Alignment Exercise 1

Using a competition target and a rifle rest, have the cadets move between the different diagrams using the proper technique to adjust natural alignment. Cadets should not dry fire or fire any pellets at the target. To test if their alignment is fine, cadets should close their eyes, relax their positions and then open their eyes. If they are centred with the aiming mark, then their alignment is good and they should move on to the next diagram. They should repeat this exercise a few times.

Using a rest makes it much easier for the cadets to see the impacts of breathing in and out. When practising, have the cadets retain their breath for longer periods to see the negative impacts of over-holding. Remind the cadets to still focus on the feel for the position.

### Breathing Exercise 1

Using a grouping target and a rifle rest, have the cadets focus on the front sight and the impact breathing in and out has on it. Have the cadets take a deep and slow breath until they finally hold it. Have them look at how still the rifle is when they are not breathing. Repeat this for a few shots.



## WEEK 4 – APPLICATION OF MARKSMANSHIP PRINCIPLES III

### Training diary

- Explain the benefits of using a diary
- Give diary examples
- Cadets start to keep a diary

### Aiming

- The theory of aiming
- The importance of sight alignment
- The perfect sight picture concept
  - Cadets fire groups using a rest while emphasizing proper sight alignment (three groups of five shots)
  - Cadets fire groups using a rest while emphasizing perfect sight picture (three groups of five shots)
- Cadets select a proper front aperture
- Cadets select the proper positioning of the rear sight for best focus
  - Cadets fire groups using a rest while trying out different aperture sizes as well as different rear sight positions (four groups of five shots)
- The use of a blinder
- Cadets practice with and without a blinder
  - Cadets fire groups using a rest while emphasizing proper sight alignment (two groups of five shots)

The training diary is key in recording all the information that cadets need to know when they are firing. From now on, they should write in their diary after each training session, focussing only on positive aspects or solutions to problems.

Aiming is key in rifle marksmanship and this is why a whole session should be spent on it. This session should be broken down in three components. The first should cover sight alignment and sight picture. Place special emphasis on the distance between the eye and the sight and the focus and refocussing between the front sight and the aiming mark. For the second component, have the cadets try out both sizes of apertures and have them pick the one they like best (however, the bigger one is preferable). Move the rear sight back and forth on the sight rail and ask the cadet to place it where the focus is best. The last segment deals with the use of a blinder. Have the cadets fire with and without the blinder to see the difference but recommend that they do use one.



## WEEK 5 – APPLICATION OF MARKSMANSHIP PRINCIPLES IV

### Trigger Control

- The proper way of pulling the trigger
- Trigger control exercises
- Cadets fire groups using a rest while emphasizing trigger control (six groups of five shots)

### Follow-through

- The reasoning behind follow-through
- Follow-through exercise
- Cadets fire groups using a rest while emphasizing follow-through (six groups of five shots)

Emphasize the exercises for trigger control. Remember to spend a bit of time on the theory aspects, as this will be the cadets knowledge base as they move on. When practising follow-through, place an emphasis on calling the shots and watching the recoil. Although it is a little early in the training year for them to start calling their shots, this is a good time to introduce the subject.

### Trigger Control Exercise 1

Using a rifle rest and the back of a competition target or a blank sheet of paper, have the cadets fire about 20 dry fire shots, with their eyes closed, while focussing solely on the way the trigger feels. They should be able to predict the exact point where the trigger will break and should learn to control that. **Do not** use this exercise while live firing.

### Trigger Control Exercise 2

Using a rifle rest and the back of a competition target or a blank sheet of paper, have the cadets fire about 20 pellets while focussing solely on the way the trigger feels. They should be able to predict the exact point where the trigger will break and should learn to control that.

### Follow-through Exercise 1

Using a rifle rest and a grouping target, have the cadets fire 20 pellets while watching the effect of the recoil on the front sight. They should check to see if the recoil is always moving in the same direction and for the same amount.





## WEEK 6 – THE SLING AND MARKSMANSHIP EQUIPMENT

### Sling position

- The benefits of using a sling
- The benefits of using a jacket and glove
- Assembling the sling
- Positioning the sling on the jacket
- Adjusting the position of the sling swivel on the rifle
- Steps when adopting a position with a sling and with a rifle rest
- Cadets fire groups using a rest and a sling while emphasizing the feel of the sling (eight groups of five shots broken down in two relays)

When firing, have cadets try both a low and high sling position on the arm to see what they like best. To adjust the sling swivel, have the cadet take up a proper position without using the sling. The point of contact of their left hand on the rifle stock should be the position of the sling swivel. Adjust the length of the sling so that it supports the weight of the rifle.

Have the cadets fire with different sling tensions (both the tightness around the arm and between the arm and the rifle) to see what best suits them. The rifle should be barely resting on the rest with most of the weight supported by the sling.



## SPECIFIC PREPARATION PHASE (6 WEEKS – 15 NOV – 22 DEC)

### WEEK 7 – RELAXATION TECHNIQUES

#### Progressive Muscle Relaxation

- Explain how to do the exercise
- Cadets do the relaxation exercise

#### Relaxation – Breathing exercises

- Explain how to do the exercise
- Cadets do the breathing exercise

#### Position refinement

- Make necessary adjustments to the sling swivel position, the sling tension and the marksmanship equipment
- Cadets fire groups using marksmanship equipment and no rest (12 groups of five shots broken down in three relays)

It is very important that cadets are relaxed prior to the start of a training session. When they enter the firing range, they should leave all their problems, worries or outside thoughts at the door and focus on their performance.

Two techniques are suggested for relaxation before firing. The **first** technique is called progressive muscle relaxation. It implies progressively tensing-up muscle groups and then relaxing them. This technique is explained in detail in chapter 14 of the CCM Air Rifle Training Manual.

The **second** technique is a deep breathing technique. To practise this, cadets should lay on their backs with one hand on their stomach. They should breathe in their stomach, slowly and deeply. When doing this, they have to ensure that air is going in their stomach and not in their chest. Cadets should use at least one of these techniques before **every** training session.

Positions need to be assessed and adjusted slightly on a regular basis. When modifying a position, it is very important to only do one modification at a time in order to correctly verify the impacts of the change. The modifications should be tested for a few relays in order to ensure that they work properly or do not work at all.



## WEEK 8 – DEVELOPMENT OF A SHOT ROUTINE I

### Natural alignment

- Reemphasize the importance of natural alignment
- Do natural alignment exercise
- Cadets fire groups of five shots (two relays of three groups)

### Shot routine

- Describe the importance of a shot routine
- Develop a shot routine with the cadets
- Have cadets write down their shot routine
- Have cadets fire while emphasizing this shot routine
- Cadets fire groups of five shots (two relays of three groups)

Natural alignment is very difficult for cadets to comprehend and for coaches to verify. This concept must therefore be reemphasized on a regular basis throughout the training year.

### Natural Alignment Exercise 1

Using a competition target, have the cadets move between the different diagrams using the proper technique to adjust natural alignment. Cadets should fire two pellets at each diagram. To test if their alignment is fine, cadets should close their eyes, relax their positions and then re-open their eyes. If they are centred with the aiming mark, then their alignment is good and they should fire their two shots and move on to the next diagram. They should repeat this exercise twice.

Developing a shot routine is essential in a sport such as marksmanship. A well-defined shot routine will ensure consistency for every shot and will keep the cadet's focus on the task at hand by helping to prevent unwanted thoughts to enter their minds. By abiding to their shot routine, cadets will remember every step in their shot process and will increase their probability of firing perfect shots.

When developing a shot routine, cadets should use key words for each action they will take. At first, these actions will take place in the conscious mind, meaning that cadets will have to think of every step in order to perform them. However, as they gain more experience through hours of training, many of these actions will become natural to them, or done subconsciously. Key words and actions that could be used are as follows:

**Relax** – Make sure the position is comfortable and that all the muscles are relaxed

**Align** – Properly align position with the target

**Breathe** – Initiate the breathing sequence as described earlier

**Hold** – When comfortable, stop breathing and focus on properly holding the rifle

**Squeeze** – When hold is perfect, start squeezing the trigger slowly and constantly

For more experienced cadets, less key words may become necessary. For example, after saying **Relax**, cadets will learn to automatically align their position and their breathing sequence will begin instinctively.



## WEEK 9 – DEVELOPMENT OF A SHOT ROUTINE II

### Shot routine

- Review shot routine
- Review aiming process and have cadets fire two groups of five shots focussing on proper sight alignment
- Review breathing sequence and have cadets fire two groups of five shots focussing on proper breathing
- Review the trigger control process and have cadets fire two groups of five shots focussing on proper trigger control
- Incorporate a verification stage to the shot routine
- Have cadets write down their new shot routine
- Cadets fire groups of five shots (two relays of four groups)

It is important to focus a second week of training on the shot routine, as this sequence of actions must become second nature to the cadets. It is crucial for them to understand that they must not deviate from their sequence when they fire a shot. Doing this while focussing on specific components will only make the whole sequence stronger in the long run.

After the cadets have practised their shot routine, it is now time to mention how and when this routine should be broken in order to prevent bad shots from being fired. They must understand that as soon as they deviate from their original sequence, they must return to it or **break the routine and start over**. The following should be adhered to when in the firing sequence:

<b>Position relaxed</b>	– OK – proceed to natural alignment – NO – put rifle down and start over
<b>Natural alignment</b>	– OK – proceed to breathing sequence – NO – put rifle down and start over
<b>Breathing sequence</b>	– OK – proceed to holding – NO – restart breathing sequence or put rifle down and start over
<b>Holding</b>	– OK – proceed to squeezing – NO – restart breathing sequence or put rifle down and start over
<b>Squeezing</b>	– OK – proceed to follow through – NO – restart breathing sequence or put rifle down and start over





## WEEK 10 – ENDURANCE TRAINING I

### Physical training

- Describe the importance of physical training (cardio and endurance)
- How physical training fits in with marksmanship training

### Endurance training

- Explain why endurance training is a key component of the annual plan
- Cadets fire groups of five shots (three relays of eight groups)

Physical training is important in rifle marksmanship because the heart rate of an individual will directly affect their breathing capability. On top of stretching exercises, cadets who intend to excel in the sport of marksmanship should practice regular fitness activities such as running, cycling, swimming or any other sports that emphasize cardiovascular training.

In order to build up their endurance, cadets should do some light weight training. Cadets who want to become excellent marksmen should not try to become body builders as too much muscular strength may actually hinder performance. Cadets should focus on performing a higher level of repetitions with weights that are not too heavy. This will build their muscular endurance and not strength or power.

In conjunction with weight training, cadets should focus on developing the specific muscles that affect their positions. To do so, there is nothing better than to spend long amounts of time in position. By doing so, the body becomes accustomed to the way limbs are positioned and the weight and feel of the rifle. An easy exercise to practice this is to have cadets fire more shots than a normal match would require. A normal competition relay would have cadets firing 20 competition shots as well as a few sighting shots; therefore, in order to feel comfortable firing the shots, cadets should train to be able to fire twice this amount.

When doing endurance training, even though cadets may become tired, it is crucial for them to keep focused for all the shots. The shot routine developed in previous sessions should be reinforced throughout this practice. Breaks could be taken between groups but cadets should remain in position.



## WEEK 11 – MENTAL TRAINING

### Concentration

- Explain the importance of concentration in marksmanship
- Do concentration exercises

### Perception

- Explain the concept of perception
- Cadets fire groups of five shots (one relay of two groups) focussing on the position (upper body)
- Cadets fire groups of five shots (one relay of two groups) focussing on the position (lower body)
- Cadets fire groups of five shots (one relay of two groups) focussing on sight alignment
- Cadets fire groups of five shots (one relay of 24 shots on 12 diagram targets) focussing on the position of the fired shot

Almost all cadets are able to fire a ten, however, few are able to repeat this ten times in a row. Even though they have the technical skills to fire a perfect shot, they are lacking the mental training to focus properly for a long period of time.

Many mental skills should be looked at when doing marksmanship training, amongst others: positive thinking, self-confidence, concentration and perception. Although the first two are extremely important, we will only focus on the latter two skills.

In order to fire perfect shots, cadets must completely focus on the task at hand. This can however be very difficult when cadets have to concentrate for long periods of time. The following six exercises should be done to improve the cadets' concentration level:

**Concentration Exercise 1.** While playing a recorded piece of music, have cadets try to focus solely on one instrument and change the focus point as the song progresses. For example, have cadets focus on the drums for 30 seconds while forgetting about all the other sounds. Then, switch the focus point to the guitar, the bass, the piano or any other instrument. When selecting music for this exercise, it is important to pick songs where the various instruments can be easily identified and isolated.

**Concentration Exercise 2.** Make up a chart of eight rows and eight columns and write down in random order the numbers 23 to 86 in the various cells. Then have the cadets find the numbers in order from the first to the last. This exercise can also be done in reverse order.

The second point that needs to be emphasized is perception. This could be described as the point of contact between the brain and the outside world. Everything that we see or feel is first experienced by our sensory organs. This training session should be used to examine perception as it relates to position and possible weaknesses in technical skills.

**Perception Exercises 1 and 2 – Perception of the position.** During live or dry firing, cadets should fire while placing emphasis on how their position feels. For the first exercise, they should focus on how their upper body feels, more specifically their arms, hands and shoulders as well as their head and neck. They should try to fire every shot with a position that feels (and is) consistent. The exercise should be repeated with emphasis on the lower body, with specific attention to the mid-section, the legs and the feet.



**Perception Exercise 3 – Perception of the sight picture.** Knowing what happens to the sight picture while aiming and holding is crucial in identifying potential positional or technical weaknesses. Therefore, cadets should be able to answer the following questions after every shot:

- What movements were made by the rifle during the holding and aiming process?
- Where was the front aperture at the moment the shot was released?
- In what direction did the recoil cause the front sight to go after the shot was released?

**Perception Exercise 4 – Calling the shots.** One of the most important and complicated exercise to do is to be able to correctly identify good shots from bad shots, as well as to identify the placement of poor shots on the target. Being able to do this will allow cadets to properly centre their group (which is key in marksmanship) without taking into account poor shots. For this exercise, cadets should record the estimated position of their shots on a piece of paper and then compare it upon completion of the firing sequence. They should first centre their group and then fire one shot at each of the 12 diagrams of a competition target. During this exercise, the coach should emphasise that cadets should still strive to get perfect shots. This exercise can be done twice.



## **WEEK 12 – BREAK**

Before starting the pre-competition phase, it is recommended to take a week off. This will enable the cadets to do other activities and when they come back, the level of motivation should be at its highest. This week could also be used to catch up on any of the subject matter that couldn't be covered or it could be used as a review for the concepts that are a little more difficult to comprehend.





## PRE-COMPETITION PHASE (7 WEEKS – 22 DEC – 15 FEB)

### WEEK 13 – MATCH ROUTINE I

#### Sight Adjustments

- Explain how to adjust sights
- Explain when to adjust sights

#### Match routine

- Explain how to set up the targets
- Use of sighting shots
- Role of the Cadet Coach
- Communicating with the Cadet Coach
- Order in which to fire the diagrams
- Cadets fire two relays of two competition targets

A brief overview on how the sights are to be adjusted should be done to ensure that everyone on the team has the same interpretation of the amount of sight corrections needed for various adjustments. Also, time should be spent on making the cadets understand the correct moment to change the sight settings. It should be emphasized that sight corrections should not be made until at least three sighting shots have been fired and that a group has been formed. Further on as the match progresses, sight adjustments should be made to keep the group centred directly in the middle of the ten ring. These sight adjustments should not be made after every shot but rather after a few shots in which a tendency can be perceived.

Competition targets are always shot in pairs. When setting them up it is imperative to place them as close as possible together, being careful not to overlap them. They should be positioned a few inches off the ground. The targets can be oriented in two directions, either vertically or horizontally. It is recommended to position them vertically as the amount of movement between the various diagrams is decreased and made easier.

Before starting a match, cadets must fire between five and ten sighting shots. If a cadet fires less than five shots, their position will not be settled in and changes in the natural point of aim may occur during the match. Firing more than ten shots may place the cadet under a time constraint and hinder their performance. A good sighting routine would be to fire three shots, adjust the sights and fire two more to confirm the sight change. If the group is perfectly centred, the cadet should start their match. If not a few more sighting shots should be taken.

The Cadet Coach is used to keep the marksman's group centred and to ensure that everything is going well on the firing line. The Cadet Coach should always remain calm and show no emotions after good or bad shots. Although the Cadet Coach and the cadet who fires cannot communicate verbally, it is possible for them to communicate through signs or by way of writing. The marksman should not turn around after every shot to see their Cadet Coach but should keep firing until the Cadet Coach taps their foot. This will enable the marksman to develop a good rhythm and will save time. Since the marksman relies on the Cadet Coach for sight adjustment, he/she should not have access to a spotting scope.

The diagrams on the competition target do not need to be fired in the order in which they are numbered. Therefore, the first diagram to be fired should be one adjacent to the sighting diagrams, thus minimizing the movements between diagrams. The order in which the diagrams are fired is irrelevant as long as the movements between each diagram are minimized. However, that order should be the same for all cadets on the team and should be adhered to every time a cadet fires a match. This will reduce the chances for cadets to fire two pellets in one diagram, skip a diagram or lose track of their firing order.



## WEEK 14 – MATCH ROUTINE II

### Natural alignment

- Review the concept of natural alignment
- Do natural alignment exercises

### Match routine

- Review the Match Routine detailed in the previous session
- Cadets fire two relays of two competition targets

As mentioned earlier, natural alignment is crucial in marksmanship, especially when firing on multi-diagram targets. The fact that cadets need to adjust their natural alignment between every diagram needs to be reinforced. To practice this concept, cadets should perform the following two exercises:

**Natural Alignment Exercise 1.** Using a competition target, cadets should fire groups of five shots in the corner diagrams of the target. This will exaggerate the movements that need to be done when moving from one diagram to another. A good natural alignment will ensure that all four groups are in the same spot on the various diagrams. If they are not, the cadets are not doing their alignment properly.

### Natural alignment Exercise 2

The same format as exercise 1 should be followed but with the cadets firing one shot at each corner diagram, repeating this five times. This places an even greater effort on the movements.

- The match routine explained earlier should be reviewed quickly and the cadets should fire one or two relays emphasizing this sequence as well as their shot routine.



## WEEK 15 – ENDURANCE TRAINING II

### Endurance training

- Cadets fire three relays of three competition targets

A normal competition relay would have cadets firing 20 competition shots as well as a few sighting shots; therefore, in order to feel comfortable firing the shots, cadets should train to be able to fire twice this amount.

When doing endurance training, even though cadets may become tired, it is crucial for them to keep focused for all the shots. The shot and match routines developed in previous sessions should be reinforced throughout this practice. Breaks could be taken between groups but cadets should remain in position.



## WEEK 16 – RHYTHM TRAINING

### Rhythm training

- Review breathing pattern
- Explain importance of rhythm
- Do rhythm exercises
- Cadets fire one or two relays of two competition targets

The breathing pattern directly influences the marksman's rhythm. Therefore, it is obvious that the firing rhythm for each individual will be different. The rhythm established by the cadet should be the same for both practice and competition. An example of a good firing sequence is as follows:

- 0-5 seconds – Focus
- 6-13 seconds – Adopt the position
- 14-22 seconds – Check natural alignment, start breathing sequence
- 23-30 seconds – Aiming, trigger release
- 36- 38 seconds – Follow-through
- 39-50 seconds – Pump and load the rifle

### Rhythm Exercise 1

After the cadet is in position, the coach counts out loud from 1 to 15. By the time he/she gets to 15 the shot must be fired. This is repeated for 20 shots. This will instil in the cadet the sense of time related to the timings explained above.

### Rhythm Exercise 2

The same exercise is done with the cadet counting in his head. The coach may count out loud for a few shots.

- Cadets fire two relays of two competition targets.





## WEEK 17 – ENDURANCE TRAINING III

### Endurance training

- Use of breaks
- Cadets fire three relays of three competition targets

The last session demonstrated the importance of rhythm in marksmanship. Now, it is important to understand the use of breaks in the firing sequence.

Breaks should be taken when the rhythm wanted is unachievable for one reason or another. One or two minutes of refocussing will often allow the cadet to start firing using proper shot and match routines. Breaks should also be taken when the quality of the shots fired starts to decrease. Often, a short break will prevent bad shots from being fired.

While breaking, the cadets may leave their minds wander decreasing their level of focus. This will allow them to be more rested and alert when they resume their match.



## WEEK 18 – COMPETITION SIMULATION I

### Competition simulation

- Competition exercise
- Competition simulation (two relays of two competition targets)

In order to perform well in competitions, it is crucial for cadets to train under the same conditions and rules that they will face in Zone, Provincial or National Championships. Therefore, from now on, all rules and conditions found in competitions should be adhered to when cadets fire competition targets. This should include such regulations as timings and communication between the marksman and the cadet coach.

In order for cadets to get used to the pressures they may face in a competition situation, it is recommended to do some competition exercises. A few exercises have therefore been planned for the next few weeks.

### Competition Exercise 1

Cadets fire ten 10's in the fewest amount of shots. This means that after sighting in the rifle, cadets keep firing at the same diagram until they achieve a ten. Depending on the skill level of the cadet, the standard could be decreased to hitting the nine ring instead. This exercise will place emphasis on firing perfect shots and will enable cadets to see a target with all ten bulls shot out. This can be repeated if time permits.

- Cadets fire two relays under competition conditions.



## WEEK 19 – COMPETITION SIMULATION II

### Final team selection

- Ensure final team is picked by this time

### Competition simulation

- Competition exercise
- Competition simulation (Cadets fire two relays of two competition targets)

By this time, the team composition should be finalized. Therefore, team strength should be decreased to a minimum of two juniors plus three more cadets, for a total of five cadets. This will allow cadets on the team more time to prepare during the competition phase of this training plan.

**Competition exercise 1.** Each cadet must fire a string of shots, hitting a specific value. The cadet with the longer string wins. For example, cadets have to fire the most consecutive 10's possible. Depending on the skill level of cadets, the value could be decreased to a nine or eight. However, this has to remain challenging for the cadets. Cadets from all skill levels can also compete against each other since the standard varies according to their proficiency levels. This exercise should be repeated four or five times.

Then the cadets fire two relays under competition conditions.



## COMPETITION PHASE (6 TO 8 WEEKS – 15 FEB – 15 APRIL)

### WEEK 20 – DEVELOPMENT OF TACTICS

#### Development of tactics

- Develop contingency plans for various situations
- Cadets fire two relays of two competition targets

In order to cope with every possible situation that can occur during a match, it is crucial to define contingency plans ahead of time. Listed below are a few situations that may occur and what to do in order to deal with them:

**Broken equipment** – Have a spare rifle nearby, have the team equipment organised in the waiting area and know where all the equipment is.

**Range distractions** – Break, refocus on the task at hand and try to eliminate the distraction. Resume only when ready.

**Two shots in one diagram or skipping a diagram** – Listen to the Cadet Coach, do not doubt the Cadet Coach, and ensure the cadet coach is very familiar with the rules.

**Infractions noted** – Relax, fix problem (officials are only doing their job) and resume when re-focussed.

**Cease-fire** – Break, resume upon the command. There is nothing to do but wait so keep focussed and relaxed. Stay in position if allowed to.

**Uncomfortable position** – Stand-up and lay down again. Repeat until the position is fine.

**Strange shot pattern** – Check sights, sling swivel, counter weight to see if they are tight on the rifle. Change rifle if necessary.

Cadets should worry about what they can control, not about everything else. They should also remember that the better prepared they are, the better their performance will be.

Cadets should fire two relays of two competition targets.





## WEEK 21 – COMPETITION SIMULATION III

### Competition simulation

- Competition exercise
- Competition simulation (Cadets fire two relays of two competition targets)

**Competition exercise 1.** After sighting in their rifle, cadets stand up, lay down again and start their match. After every five shots, they stand up and reassume their position. This is all done without having the opportunity to return to firing sighting shots. This exercise places emphasis on such skills as adopting a constant position, performing natural alignment and keeping to the shot and match routines. This exercise can be done twice.

Then the cadets fire two relays under competition conditions.



## **WEEK 22 – ENDURANCE TRAINING IV**

### **Endurance training**

- Cadets fire three relays of three competition targets

When doing endurance training, even though cadets may become tired, it is crucial for them to keep focussed for all the shots. The shot and match routines developed in previous sessions should be reinforced throughout this practice. Breaks could be taken between groups but cadets should remain in position.



## WEEK 23 – COMPETITION SIMULATION IV

### Positive thinking

- Briefing for upcoming Zone Championship
- Refocussing on team goal

### Competition simulation

- Competition simulation (Cadets fire two relays of two competition targets)

It is important to brief cadets prior to travelling to a competition to ensure they are well aware of what this challenge represents. It is important to ensure all comments are positive and that this meeting does not place added pressures on them. The competition should actually be tackled as if it was just another practice, since all the match conditions, rules and equipment will be identical as the ones used in training.

Special emphasis should be placed on what to do with “Dead Time”, or time spent off the range. Since cadets have to rotate through on the firing line, they are left with a lot of time to spend in the team area. Therefore, a plan should be developed to keep them busy and focussed on the task at hand. For example, they could bring cards, a book or a personal music device in order to pass time. Also, cadets should avoid listening to others with regards to marksmanship techniques or routines as this is not the time to change aspects of their training or instil doubts in their minds. However, coaches are more than encouraged to go out and discuss various training techniques in order to pick up new ideas that could eventually improve their own corps or squadron program.

It is important that the goals that are set for the competition do not go beyond the capabilities of the cadets. For example, it is fine for cadets to fire their average score during a competition since this is the level at which they are comfortable. For example, if a cadet fired a pair of 99s once this year while their average is 95, it would be wrong to expect the cadet to go out and fire a pair of 99's again. If the cadet does so, then great, but that's a bonus!

Cadets should fire two relays of two competition targets after the briefing.



## **WEEK 24 – ZONE CHAMPIONSHIP**

Upon arriving at the Zone Championship, ensure you are familiar with the site and the competition organization. Get a schedule and pass it on to the cadets as soon as possible.

The most important thing to do in a competition is to follow the game plan you have laid out. This is not the time to change things, try out new ideas or modify the team's or the individual's goals. Let the cadets do what they came there to do.





## WEEK 25 – DEVELOPMENT OF A SHOT ROUTINE III

### Competition debrief

#### Shot Routine

- Reemphasise the shot routine
- Focus on the fundamentals
- Cadets fire three relays of four groups of five shots

The competition debrief should only focus on positive aspects and on solutions to weaknesses that were noted. This is also a good time to boost the self-confidence of all team members.

The shot routine that the cadets have been adhering to for the past few months should be reemphasised and practised for this entire session. Cadets should go back and fire groups of five shots while focussing on specific aspects such as their position, breathing or trigger control. This return to the basics will allow the cadets to move away from the importance of score while focussing on what is key: firing good shots!



## WEEK 26 – COMPETITION SIMULATION V

### Positive thinking

- Briefing for upcoming Provincial Championship

### Competition simulation

- Competition simulation (Cadets fire two relays of two competition targets)

It is important to brief the cadets prior to travelling to a competition to ensure they are well aware of what this challenge represents. It is important to ensure all comments are positive and that this meeting does place added pressures on the cadets. The competition should actually be tackled as if it was just another practice, since all the match conditions, rules and equipment will be identical as the ones used in training.

Cadets should fire two relays of two competition targets after the briefing.



## **WEEK 27 – PROVINCIAL CHAMPIONSHIP**

Upon arriving at the Provincial Championship, ensure you are familiar with the site and the competition organization. Get a schedule and pass it on to the cadets as soon as possible.

The most important thing to do in a competition is to follow the game plan you have laid out. This is not the time to change things, try out new ideas or modify the team's or the individual's goals. Let the cadets do what they came there to do.



## GLOSSARY

The following definitions are part of these Rules and shall be applied in all cases when using these Rules.

### **Adult Coach**

A member of the Canadian Forces or a Civilian Instructor responsible for the activities of a team.

### **Air Rifle**

A 0.177 calibre Daisy 853C or Avanti 853C air rifle.

### **Artificial Support**

Any support obtained by using devices or objects other than a marksmanship jacket and sling, (i.e., sandbag, scope mount, etc.).

### **Blinder**

A vision-blocking device attached to the rifle's sight or the Competitor's glasses and used to help prevent squinting and eye fatigue.

### **Cadet Coach**

Any Competitor at a Championship who has been appointed by the Adult Coach in the case of teams, and by the OPI in the case of individual Competitors, to carry out coaching duties on the firing point.

### **Challenge**

A request made by an Adult Coach to justify if a shot was scored or recorded properly or to correct a score which has been registered incorrectly.

### **Challenge Committee**

A committee responsible for upholding or denying a Challenge.

### **Championship**

An event that shall include training, Competition and administration activities and may include recreational / cultural activities.

### **Civilian instructor (CI)**

Civilian instructors are adults employed because they bring specific instructional ability or knowledge required by the cadet organization that is not within the CIC role or training. Civilian instructors may be given overall responsibility for an activity or a group of cadets when working under the conditions of their contract and being paid for their services.

### **Competition**

An activity that includes training and one or more Matches.

## **GLOSSARY (Cont)**

### **Competition Facility**

The site on which a Competition is held, which normally includes a firing range, an equipment check area, a Waiting Area, a scoring area, a target observation area and a Team Room.

### **Competition Year**

The Competition Year coincides with the cadet training year.

### **Competitor**

A person who is eligible to participate in a Competition and has been validly entered for this Competition.

### **Composite Team**

At the National Championship, a team composed of five (5) Competitors, including a minimum of two (2) Juniors from various cadet corps/squadrons within a given Province or Region.

### **Concurrent Matches**

When a Competitor fires two (2) or more Matches at the same time by using one (1) set of targets..

### **Course of Fire**

Details the number of pellets, number of targets and number of relays for a particular Match or Competition.

### **Cross-fire**

When a Competitor fires on the target of another Competitor.

### **Double-Random Draw**

The simultaneous drawing of two variables such as Competitor number, time, firing lane, etc.

### **Draw**

A random assignment of numbers to Competitors; the fair method of determining the order in which Competitors or teams will fire in a Competition.

### **Dry Firing**

Training that follows all the basic principles of live firing except no pellet is used or air expelled. A training technique in which the Competitor goes through the steps of aiming and firing a rifle that is not loaded.

### **Eligibility**

The status of a Competitor or team to participate in a Competition.

### **Equipment Check**

A location within the Competition facility where Competitors must pass through with rifles and marksmanship equipment to ensure their compliance with these Rules.



## GLOSSARY (Cont)

### **Final Results**

The Competition ranking list with names, individual and team scores, and other relevant details, which is published and distributed by the OPI following the finish of the Protest time after the posting of the Interim Results.

### **Firing Box**

The area on the range in which a Competitor must lie while firing. The size of the Firing Box shall be at least 1.25 m wide and 2.5 m long.

### **Highest Possible Score**

The maximum score that may be achieved on a particular target in a Match or in an entire Match.

### **Interim Results**

The Competition ranking list with names, individual and team scores, and other relevant details posted by the OPI throughout the Match, which is subject to Challenges and Protests.

### **Junior Competitor**

A cadet who has not reached his or her 15th birthday on or before 15 May of the Competition Year and is registered to participate in the CCMMS.

### **Jury**

A body of persons established to act as the authority on all matters related to a Competition.

### **Mail-In Competition**

Targets fired by individual Competitors or Teams, duly signed and witnessed, which are then posted to a collection point where they are scored and the results notified to the Competitors.

### **Match**

A marksmanship activity that has a specified number of targets to be fired and in which winners are recognized. For greater certainty, a Match does not include either Unofficial Training or Official Training.

### **Misfire**

Occurs when a loaded rifle fails to function when the trigger is depressed.

### **Official**

Any adult member of the range staff, the Chief of Competition or the Referee.

### **Official Training**

The time that the OPI must provide for training on the Competition Facility.

## **GLOSSARY (Cont)**

### **Open Competitor**

A cadet who has joined the CCOs no later than 31 January of the Competition Year, has not reached his or her 19th birthday on or before 15 May of the Competition Year and is registered to participate in the CCMMCS.

### **Organization**

The organized body of personnel responsible for conducting a Championship or Competition.

### **Penalty**

A loss of points imposed on a Competitor or a team by the Jury, Referee or Chief of Results for violation of these Rules.

### **Plug Gauge**

A small metal plug placed in shot holes in order to determine their score. This piece of metal has a flange that is exactly 0.177 inches in diameter.

### **Prone Unsupported**

The position in which a Competitor lies horizontally in the Firing Box, in accordance with Rule 15.1.

### **Protest**

A complaint submitted by an Adult Coach about the Eligibility of a Competitor, a violation of rules by another Competitor, an error by the Organization or an unfair Competition condition.

### **Provincial / Territorial Team**

At the National Championship, the members of the Unit Team and the Composite Team(s) from the same province/territory will be designated as the Provincial/Territorial Team.

### **Registration**

The notice given to an organization of the Competitors, and Adult Coaches who will participate in a Championship.

### **Scoring Overlay**

A device used to magnify a shot hole and aid in scoring.

### **Shoulder-to-Shoulder**

Those Matches that take place on one range, with all the Competitors firing side by side in a series of groups known as 'relays'.

### **Sling Hook**

A hook on the end of the sling that allows a rifle to be connected to the sling.

## GLOSSARY (Cont)

### **Squadding**

The organization of Competitors into relays in a manner that ensures all Competitors and teams receive fair treatment with regards to firing lanes and relay timings.

### **Squadding Number**

The number assigned to a Competitor or team during the draw.

### **Team Room**

An area provided for a team to gather, which has sufficient space for both team members and their equipment.

### **Time Limit**

The amount of time allocated for Official Training or a relay.

### **Trigger Pull**

The weight required on the trigger to fire the rifle.

### **Unit Team**

A team composed of five (5) Competitors, including a minimum of two (2) Juniors from the same cadet corps/squadron.

### **Unofficial Training**

The period of time that the OPI allows for training on the facility other than Official Training, and during which the facility does not have to be prepared as for the Competition.

### **Waiting Area**

An area where Competitors can prepare under quiet conditions before a relay.

### **Zeroing**

Sighting in of rifles prior to a Competition by firing pellets to test aim and to adjust sights if necessary.

### **Zeroing Pellets**

Pellets provided to a Competitor for the purpose of Zeroing a rifle.

### **Zeroing Diagram**

The diagrams in the zeroing box designated for Zeroing.



**LIST OF ACRONYMS/ABBREVIATIONS**

<b>CCM</b>	Canadian Cadet Movement	<b>DND</b>	Department of National Defence
<b>CCMMCS</b>	Canadian Cadet Movement Marksmanship Championship Series	<b>HPS</b>	Highest Possible Score
<b>CCO</b>	Canadian Cadet Organizations	<b>IAW</b>	In accordance with
<b>CF</b>	Canadian Forces	<b>NPF</b>	Non-Public Funds
<b>CI</b>	Civilian Instructor	<b>NSN</b>	NATO Stock Number
<b>CIC</b>	Cadet Instructors Cadre	<b>OPI</b>	Office of Primary Interest
<b>CO</b>	Commanding Officer	<b>RSO</b>	Range Safety Officer
<b>D Cdts</b>	Directorate of Cadets		

